



ANFAHRSCHUTZ NEU DEFINIERT!

mpm
DEUTSCHLAND

SOMMER 2022



OPTIMIERTES MATERIAL



INHALT

01	Regalschutz	Seite 08	10	Leitplanken	Seite 68
02	Poller	Seite 20	11	Höhenbegrenzer	Seite 76
03	Guard Rail	Seite 24	12	Anfahrerschutz an Ladetoren	Seite 82
04	Schutz von Kühlräumen	Seite 30	13	Barrieren für Fahrzeuge	Seite 86
05	Trennung Verkehrswege	Seite 38	14	Kabelabdeckung	Seite 90
06	Pin	Seite 44	15	Kantenschutz	Seite 92
07	Türen & Tore	Seite 48	16	Sockelleisten	Seite 94
08	Schutz von Türen und Toren	Seite 54	17	Wandschutz	Seite 98
09	Schwerer Anfahrerschutz	Seite 62			



mpm
FLEXIBLE PROTECTIONS
WAREHOUSE

OFFICE

mpm
FLEXIBLE PROTECTIONS

mpm

mpm

mpm

mpm

mpm

mpm

mpm

mpm

mpm

mpm

mpm

mpm

MATERIAL

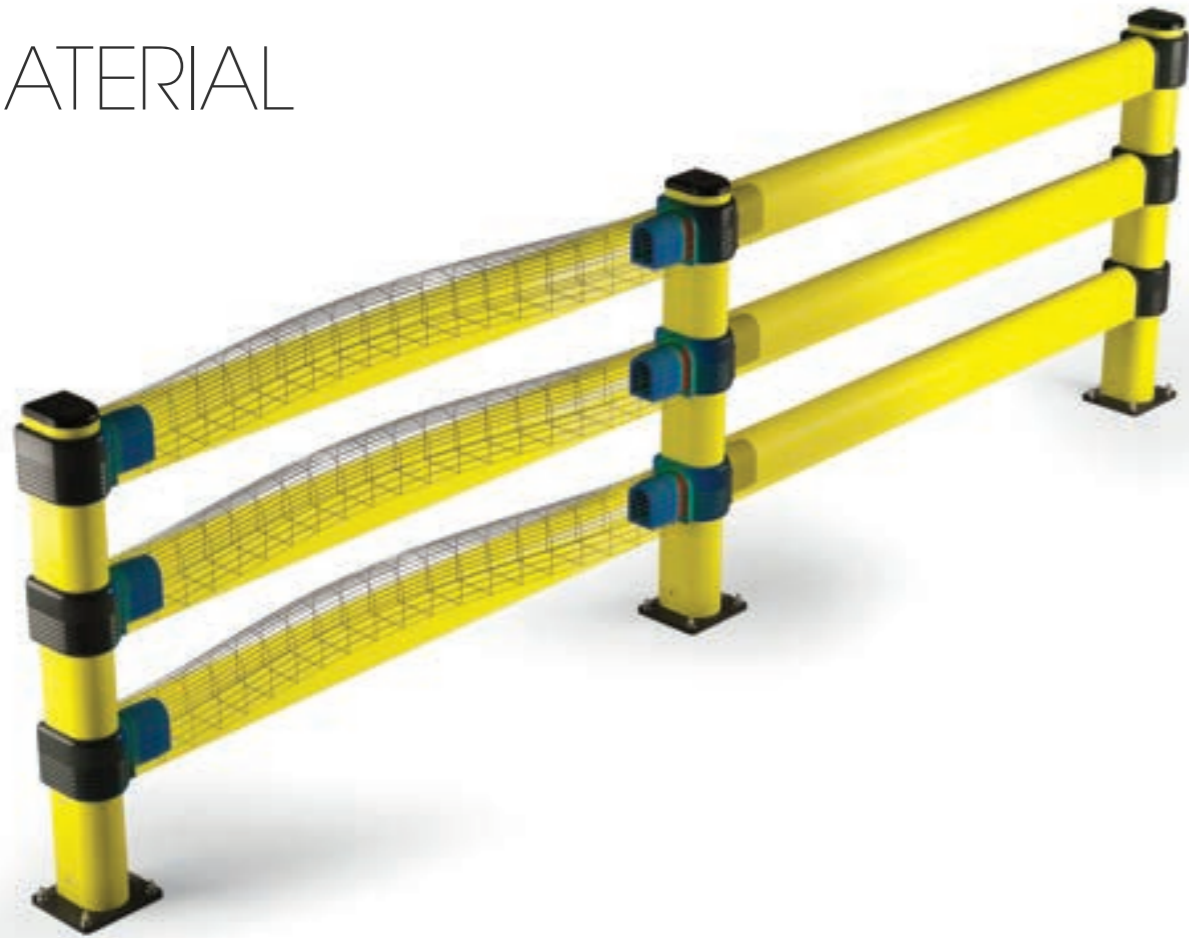

LANGLEBIG

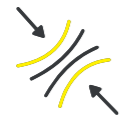

HOHE ELASTIZITÄT



ENTSPRECHEND DER NORM
UE 2015/863 (ROHS)



100%
RECYCELBAR



NICHT BRENNBAR /
SELBSTLÖSCHEND V0

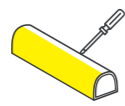

KRAZFFESTES MATERIAL /
EINFACH ZU REINIGEN



HERVORRAGENDE
SICHTBARKEIT OHNE
ANSTRICH



LEBENSMITTELKONFORM



SCHIMMEL-RESISTENT



UNGIFTIG



RESISTENT GEGEN
CHEMIKALIEN, ÖL & TREIBSTOFF



RESISTENT GEGEN
FEUCHTIGKEIT UND SALZ



FÜR TEMPERATUREN
von -30°C - + 50°C

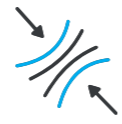

HOHE ELASTIZITÄT



ENTSPRECHEND DER NORM
UE 2015/863 (ROHS)



100%
RECYCELBAR



BRENNBARKEIT HB
GEMÄSS UL 94



LEBENSMITTELKONFORM



HERVORRAGENDE
SICHTBARKEIT OHNE
ANSTRICH



RESISTENT GEGEN
CHEMIKALIEN,
ÖL & TREIBSTOFF



SCHIMMEL-RESISTENT



UNGIFTIG



RESISTENT GEGEN
FEUCHTIGKEIT UND SALZ

ZERTIFIKAT BRANDVERHALTEN MPM REFLEX

UNSER KUNSTSTOFF IST ALS BRANDKLASSE V0 SELBSTVERLÖSCHEND ZERTIFIZIERT

MPM Barrieren sind nach dem internationalen Standard UL94 als Brandklasse V0, zertifiziert. Anfahrtschutz aus Reflex technopolymer sind:

- Schwer entflammbar;
- Selbstlöschend;
- Nicht brennend abtropfend.

Die Installation unserer Barrieren reduzieren - im Vergleich zu anderen Kunststoffen die nicht als V0 zertifiziert sind - das Brandrisiko erheblich.

Le barriere MPM sono classificate V0, secondo lo standard internazionale UL94. Le protezioni in tecnopolimero Reflex:

- Hanno un basso carico d'incendio;
- Sono autoestinguenti;
- Non propagano la fiamma e smettono di bruciare entro pochi secondi.

L'installazione delle nostre barriere riduce il carico d'incendio utilizzato ai fini del calcolo del dimensionamento del sistema antincendio, rispetto ad altre barriere in polimeri alternativi - non classificati V0.

Les barrières MPM sont classées V0, selon la norme internationale UL94. Les protecteurs en technopolymère Reflex:

- Ils ont une faible charge d'incendie;
- Ils sont auto-extinguibles;
- Ils ne propagent pas la flamme et cessent de brûler en quelques secondes.

La présence de nos barrières réduit la charge d'incendie utilisée pour le calcul du dimensionnement du système d'extinction d'incendie, par rapport à d'autres barrières en polymères alternatifs - non classées V0.

Las barreras MPM están clasificadas como V0, según la norma internacional UL94. Las protecciones de tecnopolímero Reflex:

- Tienen una baja carga de fuego;
- Son autoextinguibles;
- No propagan la llama y dejan de arder en unos segundos.

La instalación de nuestras barreras reduce la carga de fuego utilizada para el cálculo del dimensionamiento del sistema de protección contra incendios, en comparación con otras barreras de polímero alternativas, no clasificadas como V0.



**BRANDKLASSE
V-0**

STÄNDIGE WEITERENTWICKLUNG

ORANGE LINE



PASSEND FÜR: LM,
TRENNUNG FUSS-
UND VERKEHRSWEGE

CLIP 90

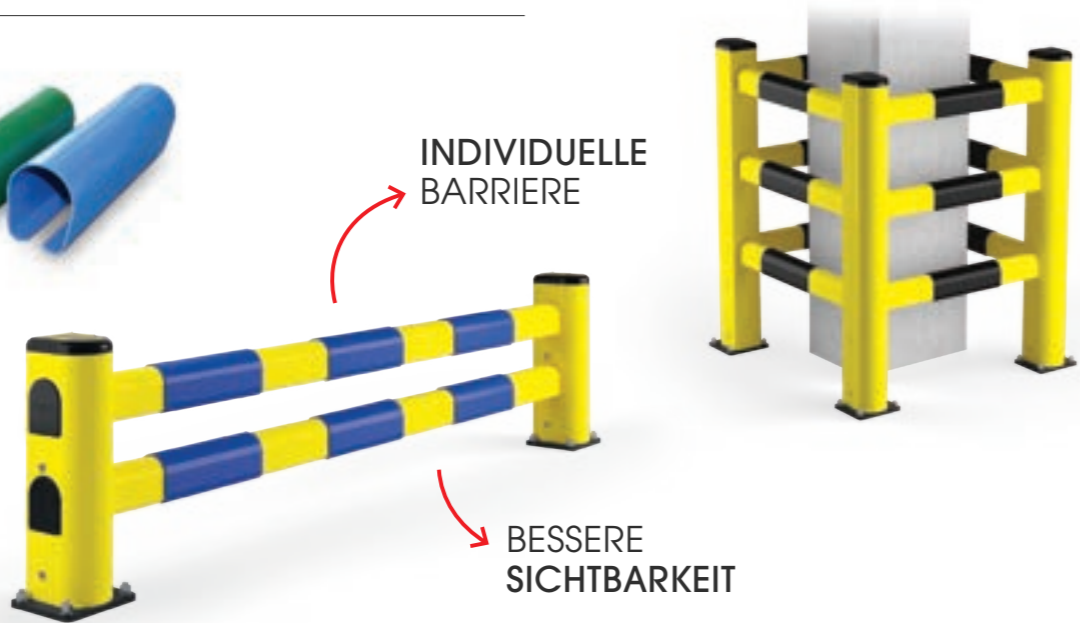
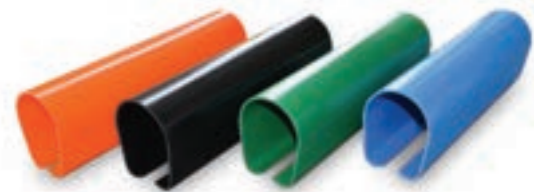

EINFACHE
INSTALLATION

INDIVIDUELLE
BARRIERE

BESSERE
SICHTBARKEIT

BESSERE
SICHTBARKEIT
FÜR NOCH
MEHR
SICHERHEIT

KÜRZEN UND BOHREN MIT

GENIUS

WUNSCHLÄNGE



FÜR IHREN MINI
KUSCHELTOWER



FÜR IHREN
KUSCHELTOWER



FÜR IHREN ECK-
FUSSGÄNGERSCHUTZ



FÜR IHREN
FUSSGÄNGERSCHUTZ



WELTWEIT EINZIGARTIG!

LÄNGEN INDIVIDUELL ANPASSBAR

01

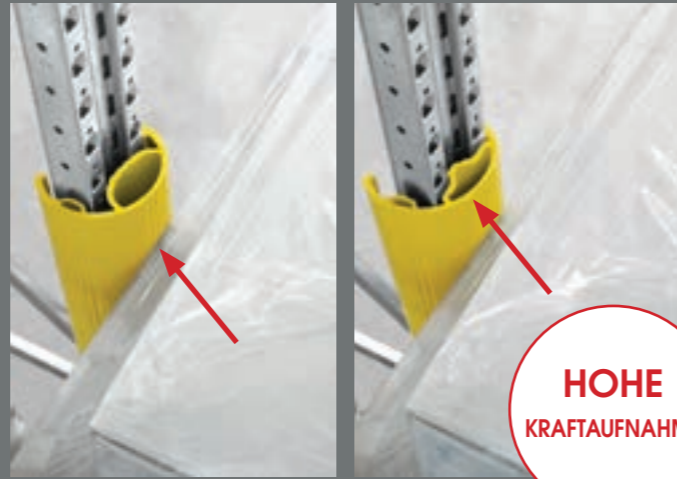

REGALSCHUTZ FLEXIBLER SCHUTZ FÜR IHRE REGALSYSTEME

Full range of techno polymer profiles for protection of warehouse racks.

Gamma completa di profili in tecnopolimeri per la protezione di scaffali.

Complète gamme de profilés en tecnopolimère pour la protection d'étagères de dépôts.

Gama completa de perfiles de tecnopolímeros para las protecciones de estanterías.

- ▶ **Zentraler weicher Schock-Absorber** gegen frontalen Aufprall.
- ▶ **Zwei seitliche Absorber** gegen Aufprall bei der Bewegung von Paletten.
- ▶ **Getestet und zertifiziert** nach EN 15512
- ▶ **Platzsparendes Design**
- ▶ **Einfache Anbringung** mit praktischem Werkzeug
- ▶ **Aussen sehr hartes, kratzfestes Material**



RPS / RPM / RPL

EINFACHE
INSTALLATION

3
INTERNE
GUMMIPUFFER



INDIVIDUELLE LÖSUNGEN
FÜR ALLE REGALTYPEN



RPS 600

Klein

Höhe 400mm auf Anfrage



VPE
VPE
Farbe

6 St. / Karton
115 St. / Palette
M



RPM 600

Mittel

Höhe 400mm auf Anfrage



VPE
VPE
Farbe

4 St. / Karton
80 St. / Palette
M



RPL 600

Gross

Höhe 400mm auf Anfrage



VPE
VPE
Farbe

2 St. / Karton
52 St. / Palette
M

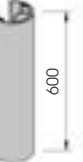

RPL XL 600

Extra Gross

Höhe 400mm auf Anfrage



VPE
Farbe

gewünschte Anzahl
M



RP CLICK

VPE

1 St. / Karton



REGALECKSCHUTZ

VERSCHIEDENE
GRÖSSEN
ERHÄLTlich

SCHNELLE
UND EINFACHE
INSTALLATION

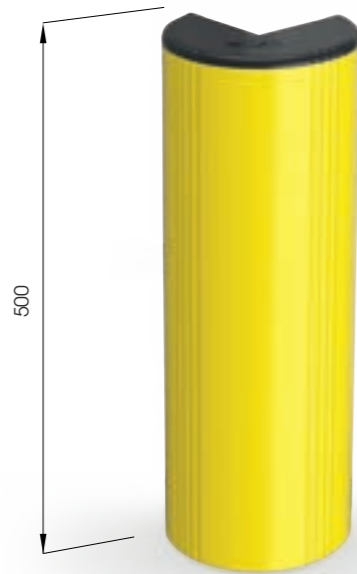

REGALECKSCHUTZ

inkl. Befestigungsmaterial

VPE
Farbe

gewünschte Anzahl
M

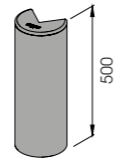

SM



VERSCHIEDENE
GRÖSSEN
ERHÄLTlich

SCHNELLE
UND EINFACHE
INSTALLATION



M12
VERZINKTER STAHL



SM 1100x400

inkl. Befestigungsmaterial

Länge 1.100
VPE gewünschte Anzahl
Farbe **B** **M**

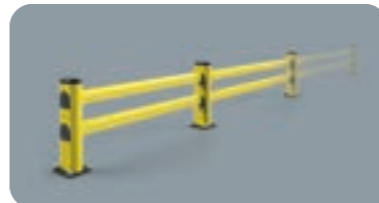
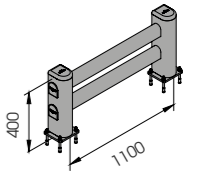

SM 1500x400 MODULAR

inkl. Befestigungsmaterial

VPE gewünschte Anzahl
Farbe **B** **M**

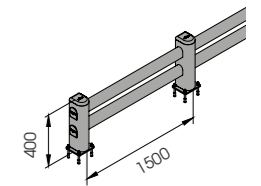

LM



VERSCHIEDENE GRÖSSEN ERHÄLTlich

SCHNELLE UND EINFACHE INSTALLATION



M12 VERZINKTER STAHL



LM RACK END 1100x500
2400x500

Länge 1.100 / 2.400 mm
VPE gewünschte Anzahl
Farbe B M

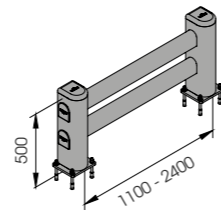

inkl. Befestigungsmaterial



LM 2000x500 MODULAR

VPE gewünschte Anzahl
Farbe B M

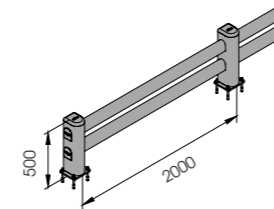

inkl. Befestigungsmaterial



LM/1 LINK



VERSCHIEDENE GRÖSSEN ERHÄLTlich



M12 VERZINKTER STAHL



LM/1 LINK RACK END 1100x500
2400x500

Länge 1.100 / 2.400 mm
VPE gewünschte Anzahl
Farbe B M

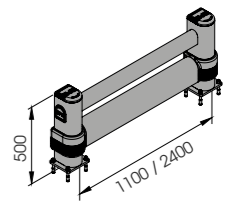

inkl. Befestigungsmaterial

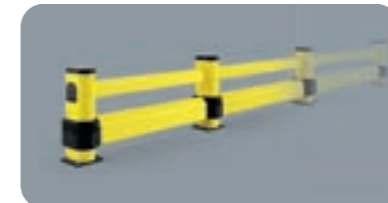

LM / 1 LINK 2000x500 MODULAR

VPE gewünschte Anzahl
Farbe B M

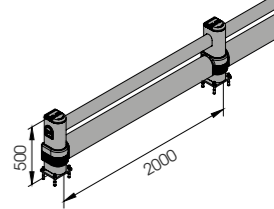

inkl. Befestigungsmaterial



LINK SINGLE



VERSCHIEDENE GRÖSSEN ERHÄLTICH

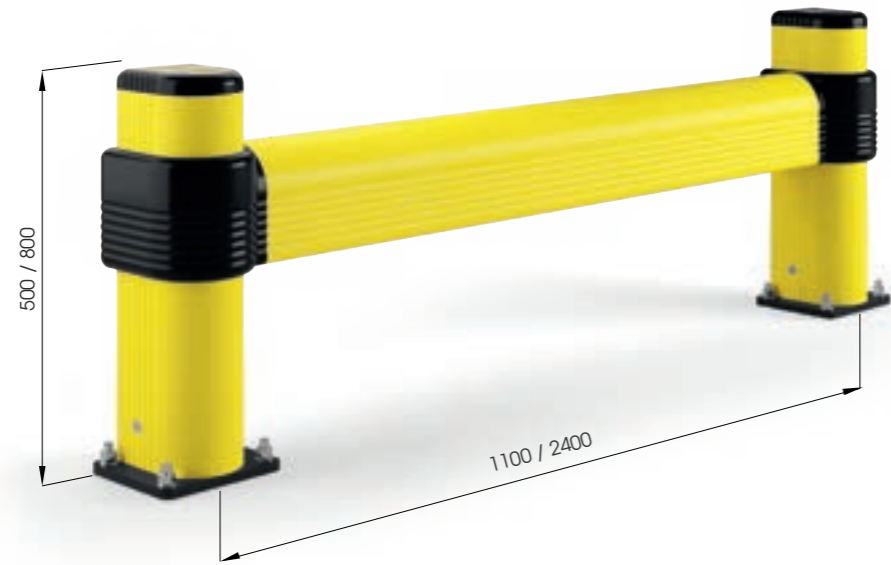

M12 VERZINKTER STAHL



LINK SINGLE RACK END
1100x500
1100x800
2400x500
2400x800

inkl. Befestigungsmaterial

Länge 1.100 / 2.400 mm
VPE gewünschte Anzahl
Farbe B M

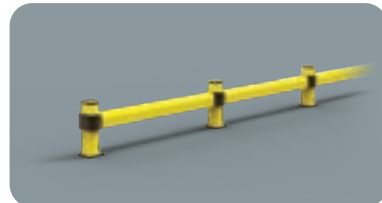
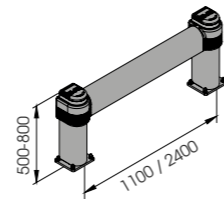

LINK SINGLE 2000x500 MODULAR
LINK SINGLE 2000x800 MODULAR

inkl. Befestigungsmaterial

VPE gewünschte Anzahl
Farbe B M

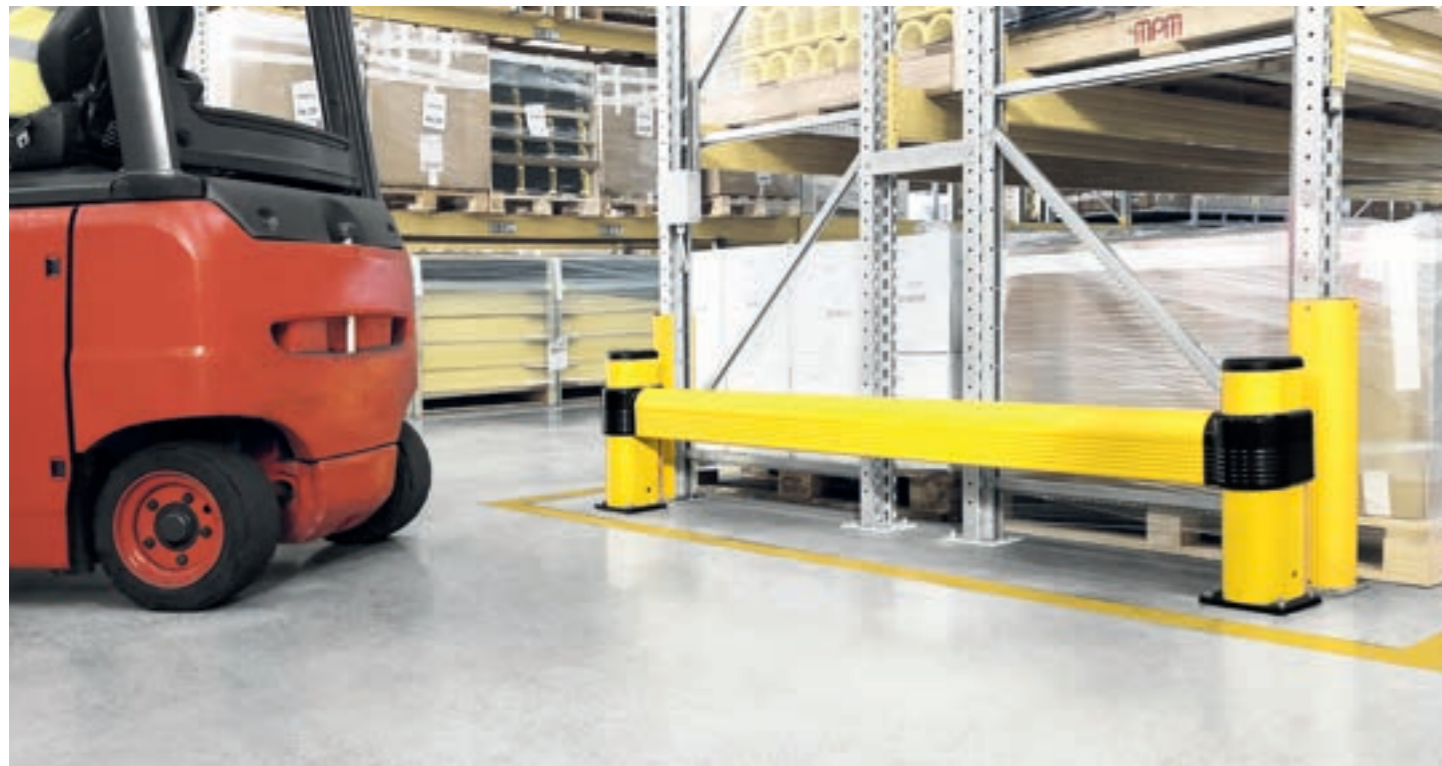
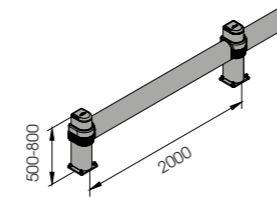

LINK LM



VERSCHIEDENE GRÖSSEN ERHÄLTICH



M12 VERZINKTER STAHL



LINK LM RACK END
1100x500
1100x800
2400x500
2400x800

inkl. Befestigungsmaterial

Länge 1.100 / 2.400 mm
VPE gewünschte Anzahl
Farbe B M

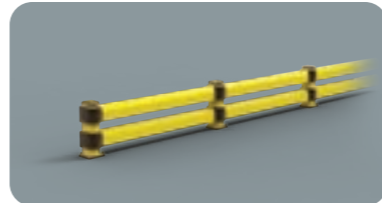
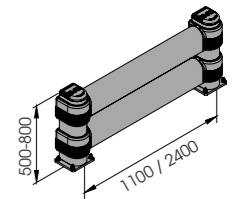

LINK LM 2000x500 MODULAR
LINK LM 2000x800 MODULAR

inkl. Befestigungsmaterial

VPE gewünschte Anzahl
Farbe B M

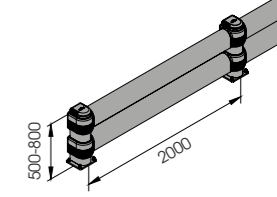

FENCE 90



VERSCHIEDENE GRÖSSEN ERHÄLTlich

SCHNELLE UND EINFACHE INSTALLATION



M12 VERZINKTER STAHL



FE 90 1100x400

Länge VPE
Farbe
Länge 1.100 mm
gewünschte Anzahl
Farbe B M



inkl. Befestigungsmaterial



FE 90 2400x400

Länge VPE
Farbe
Länge 2.400 mm
gewünschte Anzahl
Farbe B M



inkl. Befestigungsmaterial



FENCE 150



VERSCHIEDENE GRÖSSEN ERHÄLTlich

SCHNELLE UND EINFACHE INSTALLATION



M12 VERZINKTER STAHL



FE 150 1100x550

Länge VPE
Farbe
Länge 1.100 mm
gewünschte Anzahl
Farbe B M

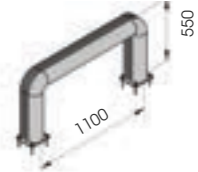

inkl. Befestigungsmaterial



FE 150 2400x550

Länge VPE
Farbe
Länge 2.400 mm
gewünschte Anzahl
Farbe B M



inkl. Befestigungsmaterial



FENCE 150 REINFORCED



VERSCHIEDENE GRÖSSEN ERHÄLTlich

SCHNELLE UND EINFACHE INSTALLATION



M12 VERZINKTER STAHL



FE 150 REF 1100x550

Länge 1.100 mm
VPE gewünschte Anzahl
Farbe B M



inkl. Befestigungsmaterial



FE 150 REF 2400x550

Länge 2.400 mm
VPE gewünschte Anzahl
Farbe B M



inkl. Befestigungsmaterial

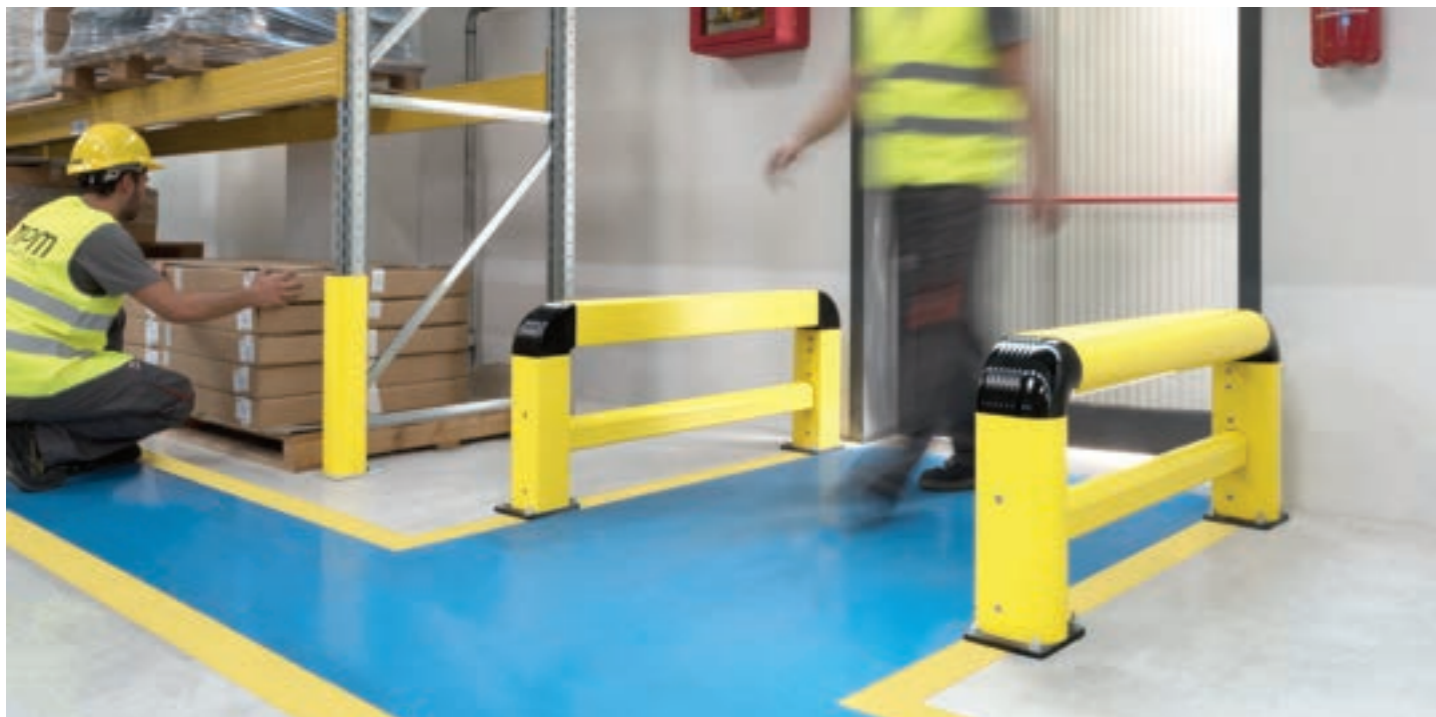

FENCE LINK



VERSCHIEDENE GRÖSSEN ERHÄLTlich

SCHNELLE UND EINFACHE INSTALLATION



M12 VERZINKTER STAHL



FE LINK 1100x550

Länge 1.100 mm
VPE gewünschte Anzahl
Farbe B M

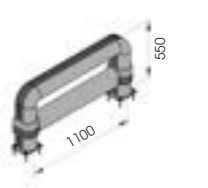

inkl. Befestigungsmaterial

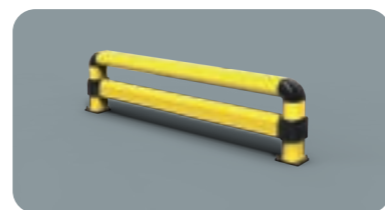

FE LINK 2400x550

Länge 2.400 mm
VPE gewünschte Anzahl
Farbe B M

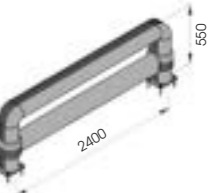

inkl. Befestigungsmaterial



02

POLLER

Zum Schutz von Toren und Maschinen und zur Kennzeichnung von Gefahrenbereichen. Lieferung mit Befestigungsmaterial.

Ideato per proteggere l'accesso a cancelli o portoni dalla movimentazione di mezzi pesanti o semplicemente per impedire l'ingresso di pedoni. Provvisto di accessori di fissaggio.

Étudié pour protéger l'accès aux portes ou entrées de grand trafic ou simplement pour marquer les zones de passage piétons. Equipé avec les accessoires d'installation.

Diseñado para proteger el acceso a puertas o portones del movimiento de vehículos pesados o simplemente para evitar la entrada de peatones. Provisto de accesorios de fijación.



GRD 90



Poller

SCHNELLE
UND EINFACHE
INSTALLATION



M12
VERZINKTER STAHL



GRD 90 250

VPE
Farbe

gewünschte Anzahl

B M

inkl. Befestigungsmaterial

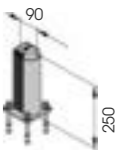

GRD 150



SCHNELLE
UND EINFACHE
INSTALLATION



M12
VERZINKTER STAHL

GRD 200

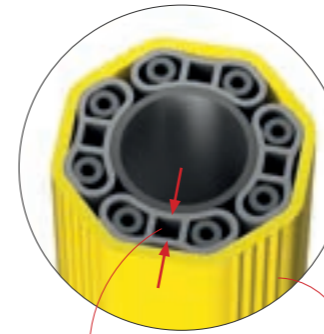

ELASTISCH

NEU
INTERNE
GUMMIPUFFER

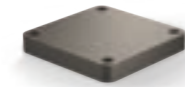

MIT SCHOCKABSORBER

SCHNELLE
UND EINFACHE
INSTALLATION



S16
VERZINKTER STAHL



GRD 150 500
800
1150

VPE
Farbe

gewünschte Anzahl
B M

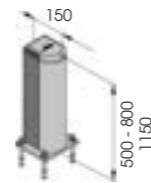

inkl. Befestigungsmaterial



GRD 200 1200
2000

VPE
Farbe

gewünschte Anzahl
M



inkl. Befestigungsmaterial



03

GUARD
RAIL

Das innovative Anfahrerschutzsystem schützt Wände, Maschinen und Betriebsausstattung und trennt zuverlässig Fahr- und Fußwege. Modernste Kunststofftechnik die Schutz, Installation und Pflege optimiert. Modulare Bauweise für ihre individuellen Anforderungen.

Sistema profili antiurto specifico per la protezione delle pareti dai carrelli in movimento. Progettato seguendo un innovativo disegno tecnico che coniuga rapidità e semplicità nelle fasi di installazione e pulizia. Disponibile in diverse lunghezze.

Nouveau système bumper, spécifique pour protéger les murs contre les mouvements des charriots. Étudié avec un modern dessin qui regroupe la rapidité et la facilité pendant l'installation et le nettoyage. Disponible en différents longueurs.

Sistema de perfiles anti-impacto específico para la protección de las paredes de los carros en movimiento. Diseñado según un diseño técnico innovador que une velocidad y simplicidad en las fases de instalación y limpieza. Disponible en diferentes longitudes.

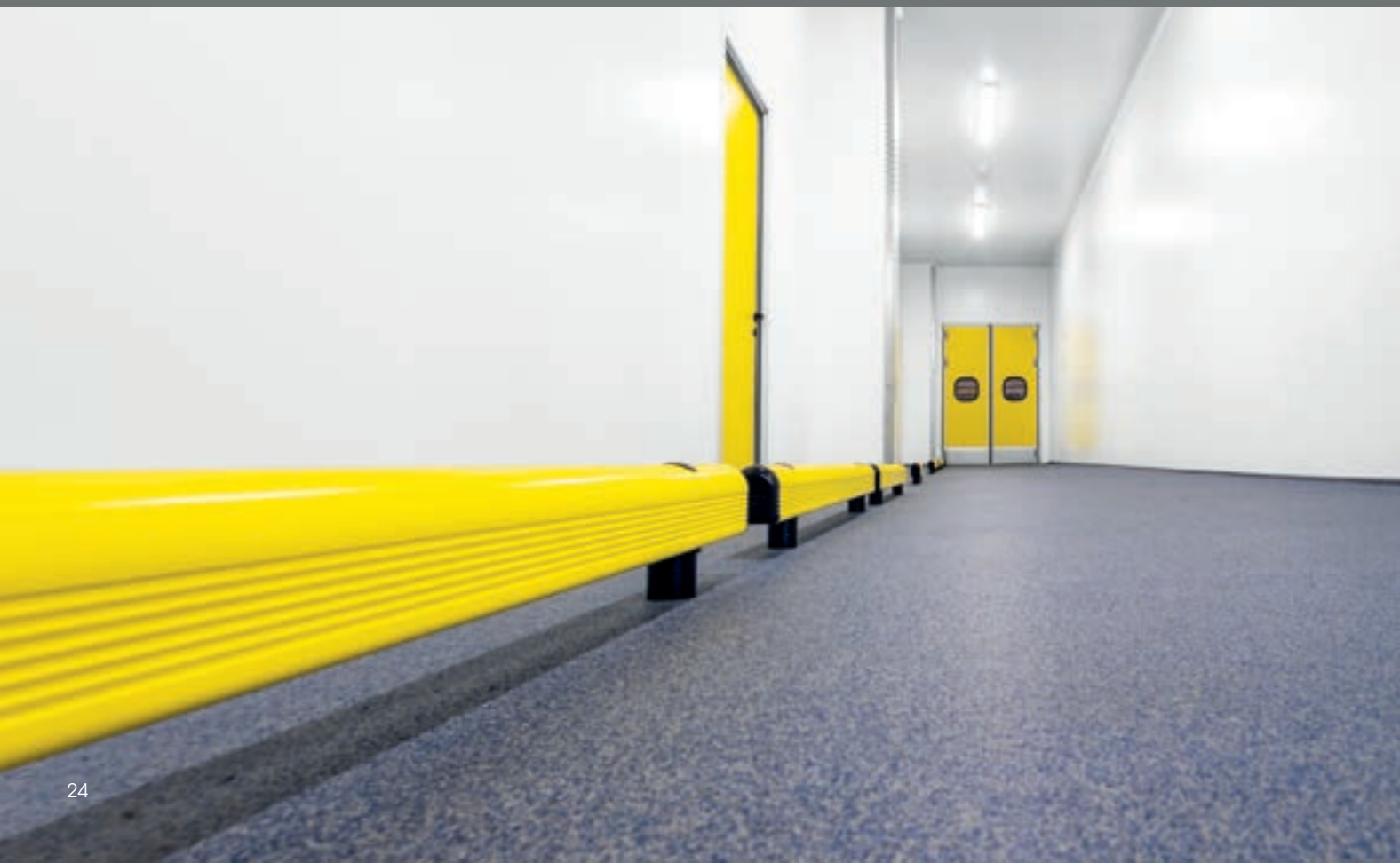

GUARD RAIL 90



SCHNELLE
INSTALLATION
MIT
SPREIZDÜBELN



M16
VERZINKTER STAHL



SF16
EDELSTAHL

ALTERNATIVE BEFESTIGUNG
HOHE KRAFTAUFNAHME MIT
KLEBEANKERN



GR 90 500
750
1000
1500

inkl. Befestigungsmaterial

Länge 500 mm
VPE gewünschte Anzahl

Länge 750 / 1000 / 1500 mm
VPE 2 St. / Karton

Farbe B M

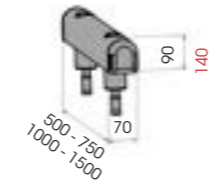

GR 90 2000
3000
4000

inkl. Befestigungsmaterial

Länge 2.000 / 3.000 / 4.000 mm
VPE gewünschte Anzahl

Farbe B M

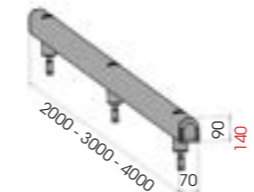

GUARD RAIL 150



EXTRASTARK
MIT
KLEBEANKERN



SF20
EDELSTAHL



GR 150 500
750
1000
1500

inkl. Befestigungsmaterial

Länge 500 / 750 /
1000 / 1500 mm
VPE gewünschte Anzahl

Farbe B M

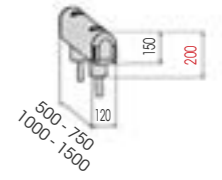

GR 150 2000
3000
4000

inkl. Befestigungsmaterial

Länge 2.000 / 3.000 / 4.000 mm
VPE gewünschte Anzahl

Farbe B M

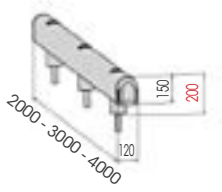

GRIN 90

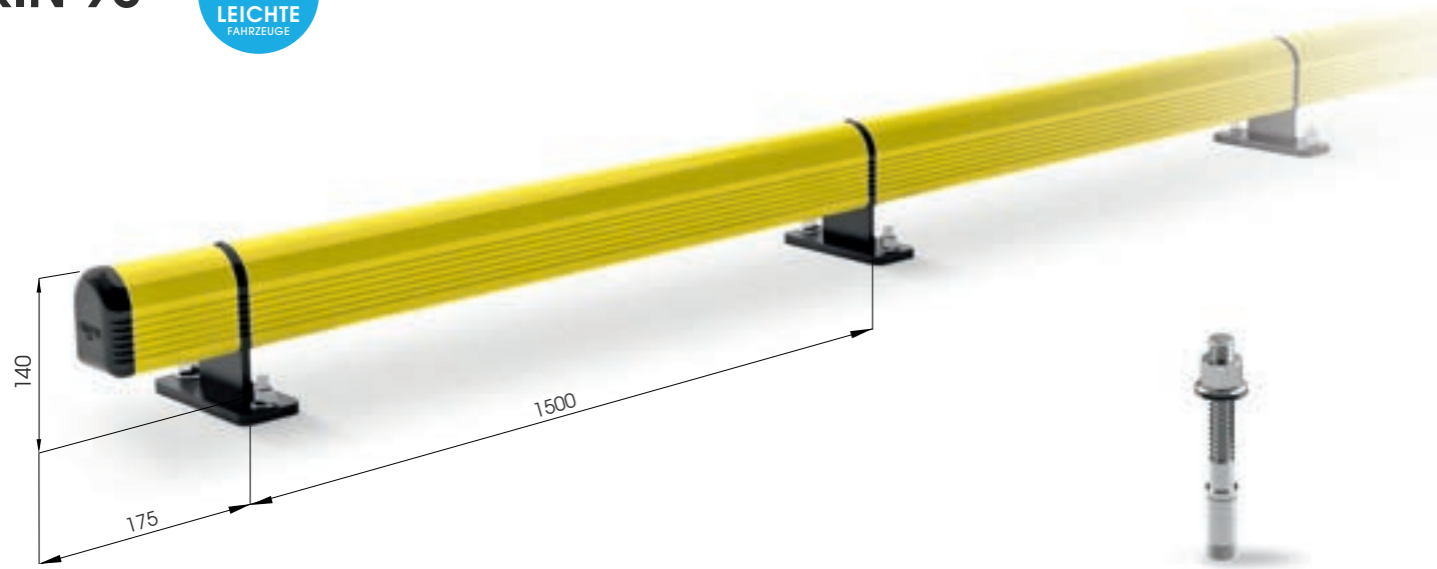

**M12
VERZINKTER STAHL**

GRIN 150



**M12
VERZINKTER STAHL**



GRIN 90 1500

Länge **1500 mm**
VPE **gewünschte Anzahl**
Farbe **M**



GRINCO 90

VPE **gewünschte Anzahl**
Farbe **M**



inkl. Befestigungsmaterial



GRINT 90

VPE **gewünschte Anzahl**
Farbe **M**



inkl. Befestigungsmaterial



GRIN 150 2000

Länge **2000 mm**
VPE **gewünschte Anzahl**
Farbe **M**



GRINCO 150

VPE **gewünschte Anzahl**
Farbe **M**



inkl. Befestigungsmaterial



GRINT 150

VPE **gewünschte Anzahl**
Farbe **M**



inkl. Befestigungsmaterial



04

SCHUTZ VON KÜHLRÄUMEN

Neue Produktlinie für Kühlräume mit Minustemperaturen. Geeignet zum Schutz von Wänden, Eingängen, Toren und Ecken.

Soluzioni specifiche per la protezione di zone a rischio d'impatto in ambienti a temperatura negativa. Ideali per proteggere angoli sporgenti, accessi e portoni, pannelli e pareti di celle frigorifere.

Solutions spécifiques pour la protection des zones à risque de collision dans les environnements à température négative. Idéal pour protéger les angles, les entrées et les portes, les panneaux et les murs des chambres froides.

Soluciones específicas para proteger las zonas con riesgo de impacto en entornos de temperatura negativa. Son ideales para proteger esquinas, entradas y puertas, paneles y paredes de las cámaras frigoríficas.



FROSTEX
RESISTANT TO LOW TEMPERATURES

-30° GEEIGNET BIS -30°



Schutz von Kühlräumen

ROD 70



Befestigungsmaterial auch in Edelstahl erhältlich



ROD 70 266

Kernbohrung Ø 38
inkl. Befestigungsmaterial

VPE
Farbe

1 St. / Karton
M

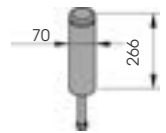

ROD 120



EINFACHES
AUSTAUSCHEN



Befestigungsmaterial auch in Edelstahl erhältlich



ROD 120 433
560
800

VPE 1 St. / Karton
Farbe M

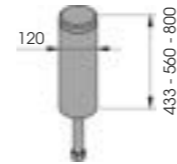

Drill Ø 56
inkl. Befestigungsmaterial



ROD FLOOR 70



EINFACHE
INSTALLATION



M16
VERZINKTER STAHL

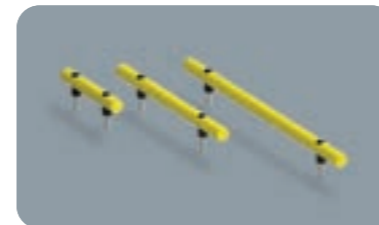

RF 70 500
1000
1500

Länge 500 / 1000 / 1500 mm
VPE gewünschte Anzahl
Farbe M

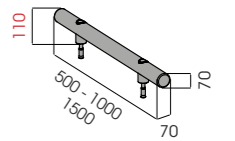

inkl. Befestigungsmaterial



RF 70 2000
3000

Länge 2.000 / 3.000 mm
VPE gewünschte Anzahl
Farbe M

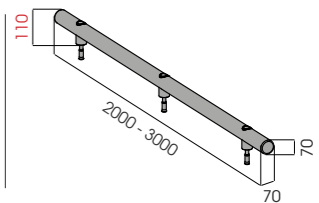

inkl. Befestigungsmaterial



ROD FLOOR 100



**EXTRASTARK
MIT
KLEBEANKERN**



ROD FLOOR 120



**EXTRASTARK
MIT
KLEBEANKERN**

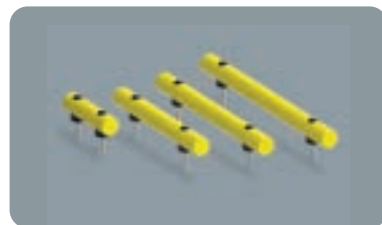

RF 100 500
1000
1500

Länge 500 / 1000 / 1500 mm
VPE gewünschte Anzahl
Farbe M

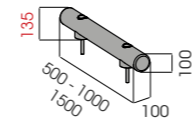

inkl. Befestigungsmaterial



RF 100 2000
3000

Länge 2.000 / 3.000 mm
VPE gewünschte Anzahl
Farbe M

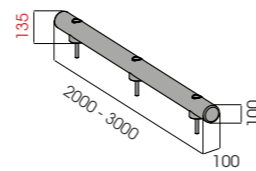

inkl. Befestigungsmaterial

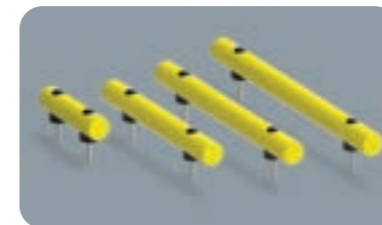

RF 120 500
1000
1100
1500

Länge 500 / 1000 / 1100 / 1500 mm
VPE gewünschte Anzahl
Farbe M

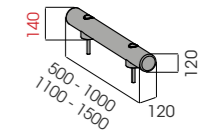

inkl. Befestigungsmaterial

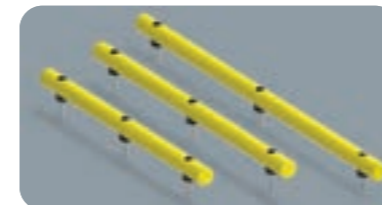

RF 120 2000
2500
3000

Länge 2.000 / 2.500 / 3.000 mm
VPE gewünschte Anzahl
Farbe M

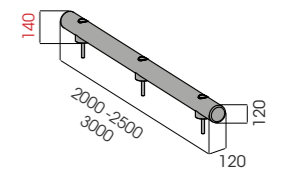

inkl. Befestigungsmaterial



ROD FLOOR 120 DOUBLE RACK END



SF20 x 450
EDELSTAHL



KEINE SCHARFEN KANTEN



GEEIGNET BIS -30°



RF 120 DOUBLE RACK END 1100

Länge 1100 mm
VPE gewünschte Anzahl
Farbe M

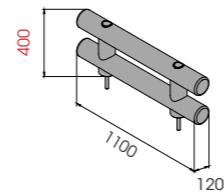

inkl. Befestigungsmaterial

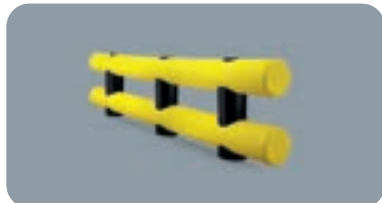

RF 120 DOUBLE RACK END 2500

Länge 2.500 mm
VPE gewünschte Anzahl
Farbe M

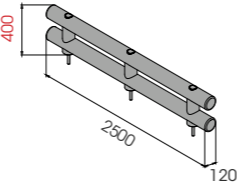

inkl. Befestigungsmaterial



ROD FLOOR 120 DOUBLE



SF20 x 450
EDELSTAHL

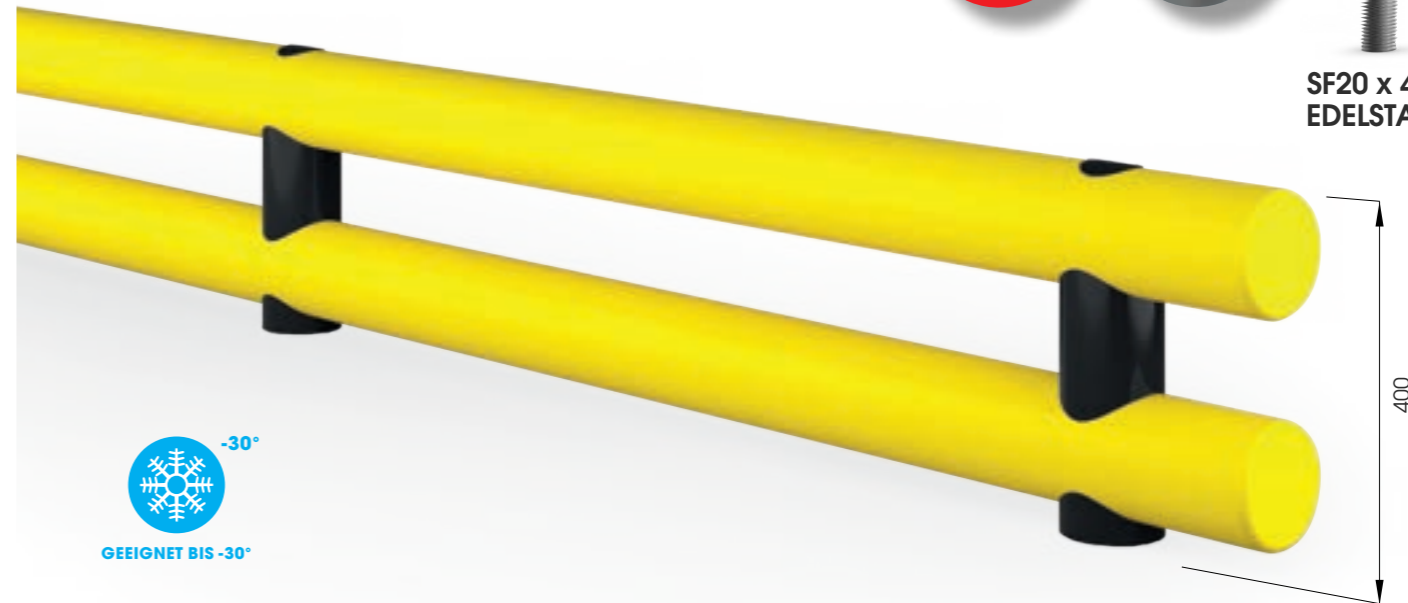

GEEIGNET BIS -30°

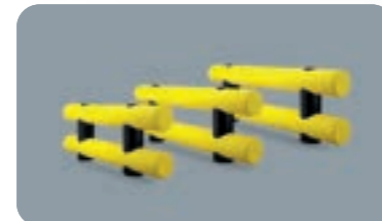

**RF 120 DOUBLE 500
1000
1500**

Länge 500 / 1000 / 1500 mm
VPE gewünschte Anzahl
Farbe M

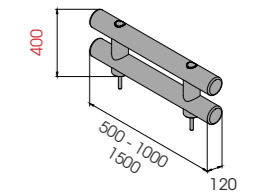

inkl. Befestigungsmaterial

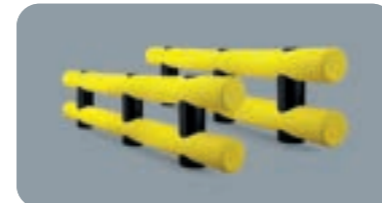

**RF 120 DOUBLE 2000
3000**

Länge 2.000 / 3.000 mm
VPE gewünschte Anzahl
Farbe M

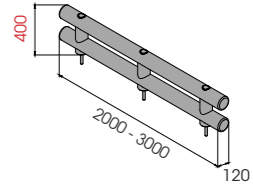

inkl. Befestigungsmaterial



05

TRENNUNG VERKEHRSWEGE

Das neue System zur Trennung von Fuss- und Verkehrswegen - spezielle Produkte für die visuelle Trennung; für leichten und schweren Verkehr geeignet; ansprechendes Industriedesign; schnelles und einfaches Installieren und Reinigen; alle Produkte sind in unterschiedlichen Längen erhältlich.

Sistema di profili antiurto specifico per la protezione delle aree pedonali dai carrelli in movimento con diverse portate di carico. Progettato seguendo un innovativo disegno tecnico che coniuga rapidità e semplicità nelle fasi di installazione e pulizia. Disponibile in diverse lunghezze.

Nouveau système bumper, spécifique pour protéger les zones piétonnes contre les mouvements des charriots. Étudié avec un modern dessin qui regroupe la rapidité et la facilité pendant l'installation et le nettoyage. Disponible en différents longueurs.

Sistema específico de perfiles antichoque para la protección de zonas peatonales de carros en movimiento con diferentes capacidades de carga. Diseñado según un diseño técnico innovador que une velocidad y simplicidad en las fases de instalación y limpieza. Disponible en diferentes longitudes.



HAND RAIL 90



SCHNELLE UND EINFACHE INSTALLATION

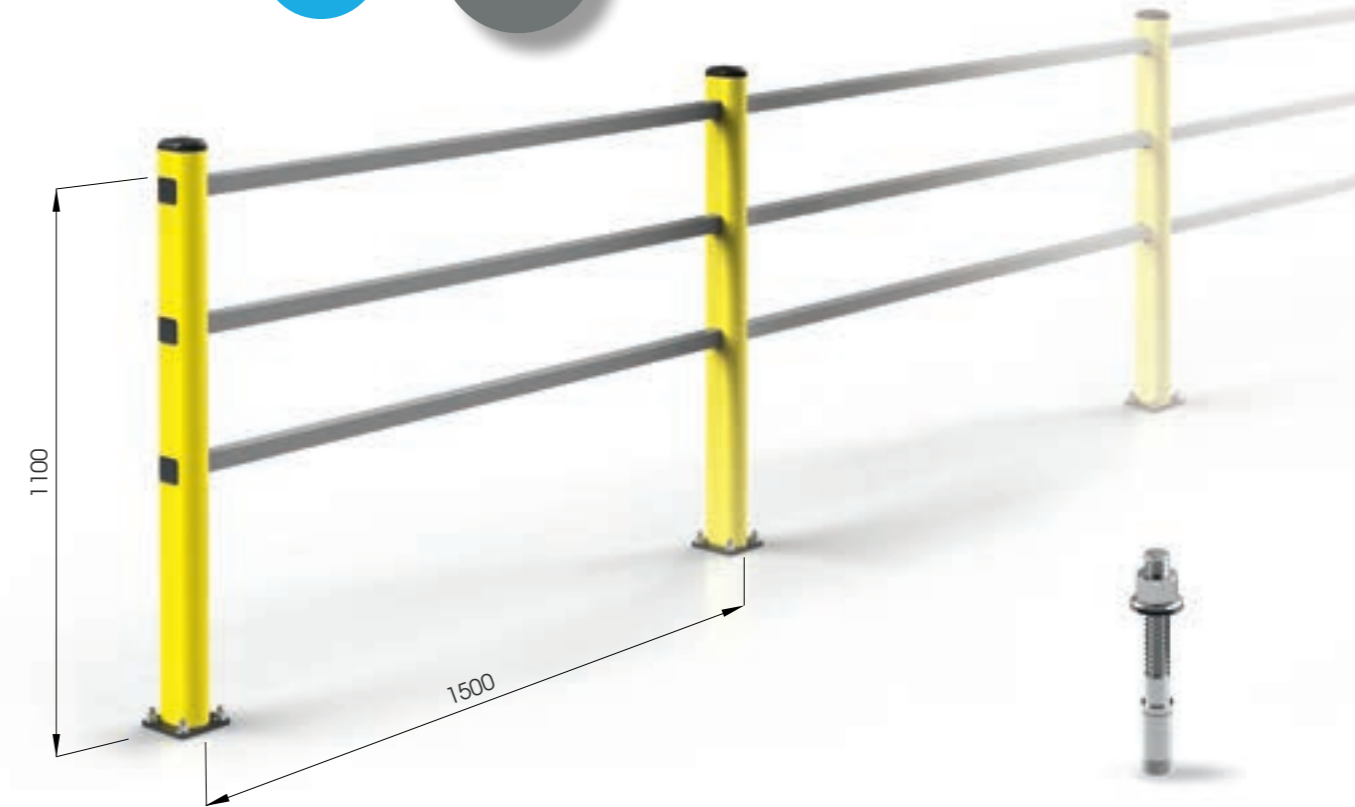

M12
VERZINKTER STAHL

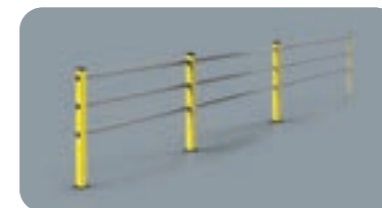

HR 90 1500x1150
MODULAR

VPE
Farde

gewünschte Anzahl
M



inkl. Befestigungsmaterial

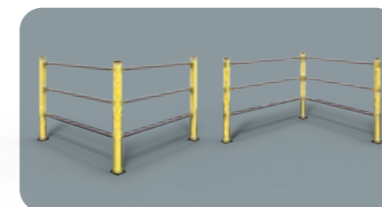

HR 90 1500x1150
CORNER

VPE
Farde

gewünschte Anzahl
M

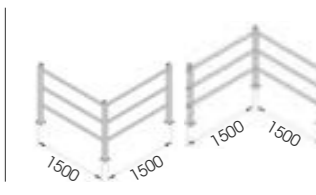

inkl. Befestigungsmaterial



PEDESTRIAN 90



SCHNELLE
UND EINFACHE
INSTALLATION



M12
VERZINKTER STAHL



**PED 90 1500x1150
MODULAR**

VPE
Farde

gewünschte Anzahl
B M



inkl. Befestigungsmaterial



**PED 90 1500x1150
CORNER**

VPE
Farde

gewünschte Anzahl
B M

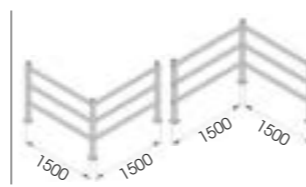

inkl. Befestigungsmaterial



PEDESTRIAN 150



SCHNELLE
UND EINFACHE
INSTALLATION



M12
VERZINKTER STAHL



**PED 150 2000x1150
MODULAR**

VPE
Farde

gewünschte Anzahl
B M

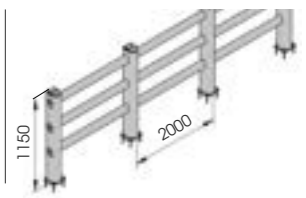

inkl. Befestigungsmaterial



**PED 150 2000x1150
CORNER**

VPE
Farde

gewünschte Anzahl
B M

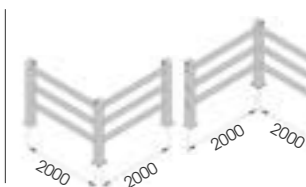

inkl. Befestigungsmaterial



PEDESTRIAN 90 REINFORCED



PEDESTRIAN 150 LINK



PED 90 REF MODULAR

VPE
Farde

gewünschte Anzahl
B M



inkl. Befestigungsmaterial



PED 150 LINK

Ecklösungen Erhältlich

VPE
Farde

gewünschte Anzahl
B M



inkl. Befestigungsmaterial



06

PIN

Neues PIN Anfahrerschutzsystem mit innovativem Verbindungssystem und neuer absorbierender Dichtung. Technisches Design das bei Installation und Reinigung Zeit und Aufwand reduziert. Das System ist flexibler und gleichzeitig wesentlich stärker.

**DAS BESTE
HIGH-PERFORMANCE
ANFAHRSCHUTZSYSTEM**



Nuovo sistema di barriere pin, progettato con un innovativo meccanismo di connessione dei traversi e una speciale guarnizione morbida ammortizzante. La barriera è ancora più resistente e flessibile all'impatto.

Nouveau système de barrière pin, conçu avec un mécanisme de connexion des traverses innovant et un joint souple spécial amortissant. La barrière est encore plus résistante et flexible aux chocs.

Nuevo sistema de barrera PIN, diseñado con un innovador mecanismo de conexión entre las barras horizontales y con una especial junta de material blando que actúa como un amortiguador. La barrera es aún más resistente y flexible al impacto.

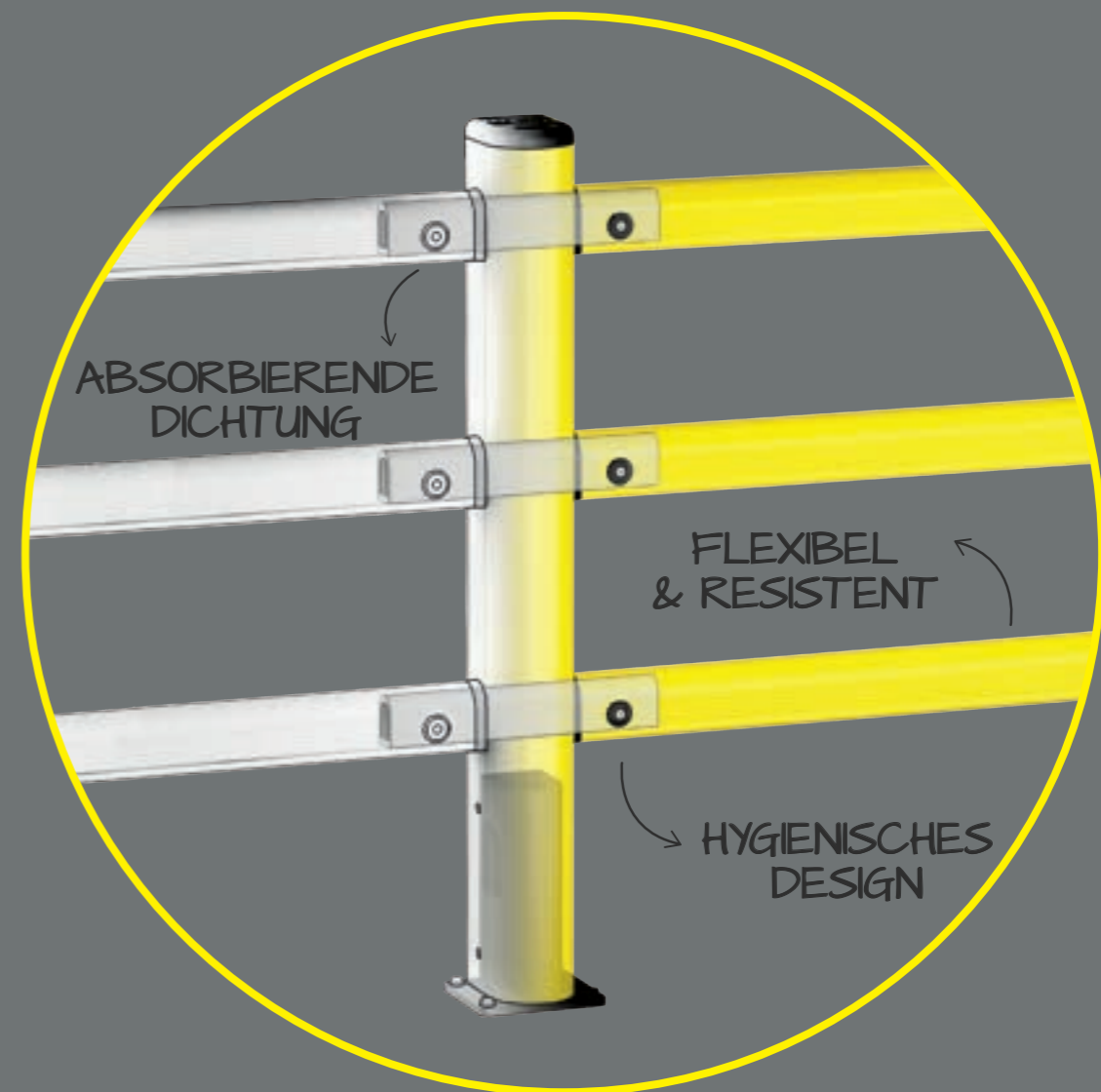

PED 150 PIN



SCHNELLE
UND EINFACHE
INSTALLATION

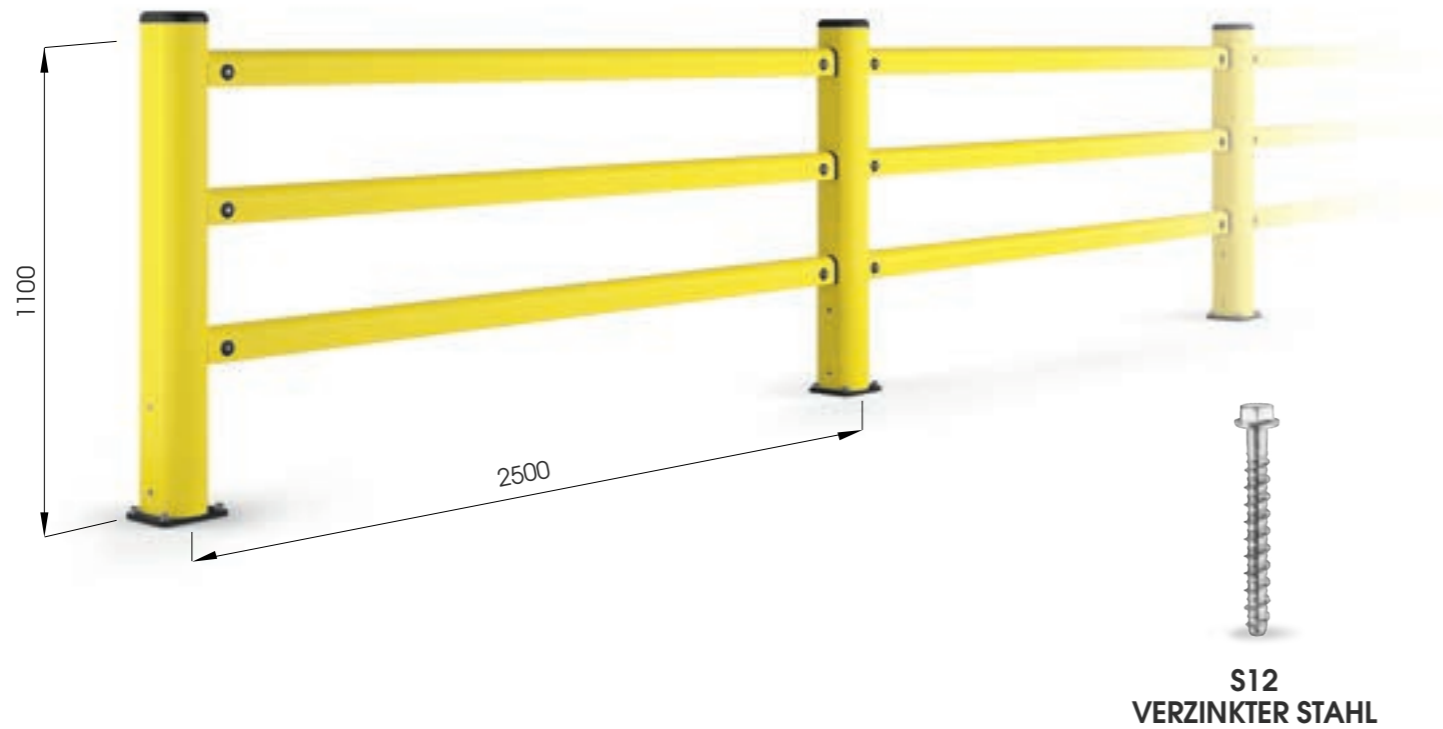

**S12
VERZINKTER STAHL**

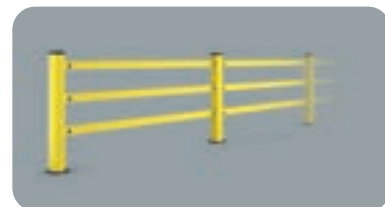

**PED 150 PIN
2500x1150**

inkl. Befestigungsmaterial

VPE
Farde

gewünschte Anzahl
B M



PED 200 PIN



SCHNELLE
UND EINFACHE
INSTALLATION

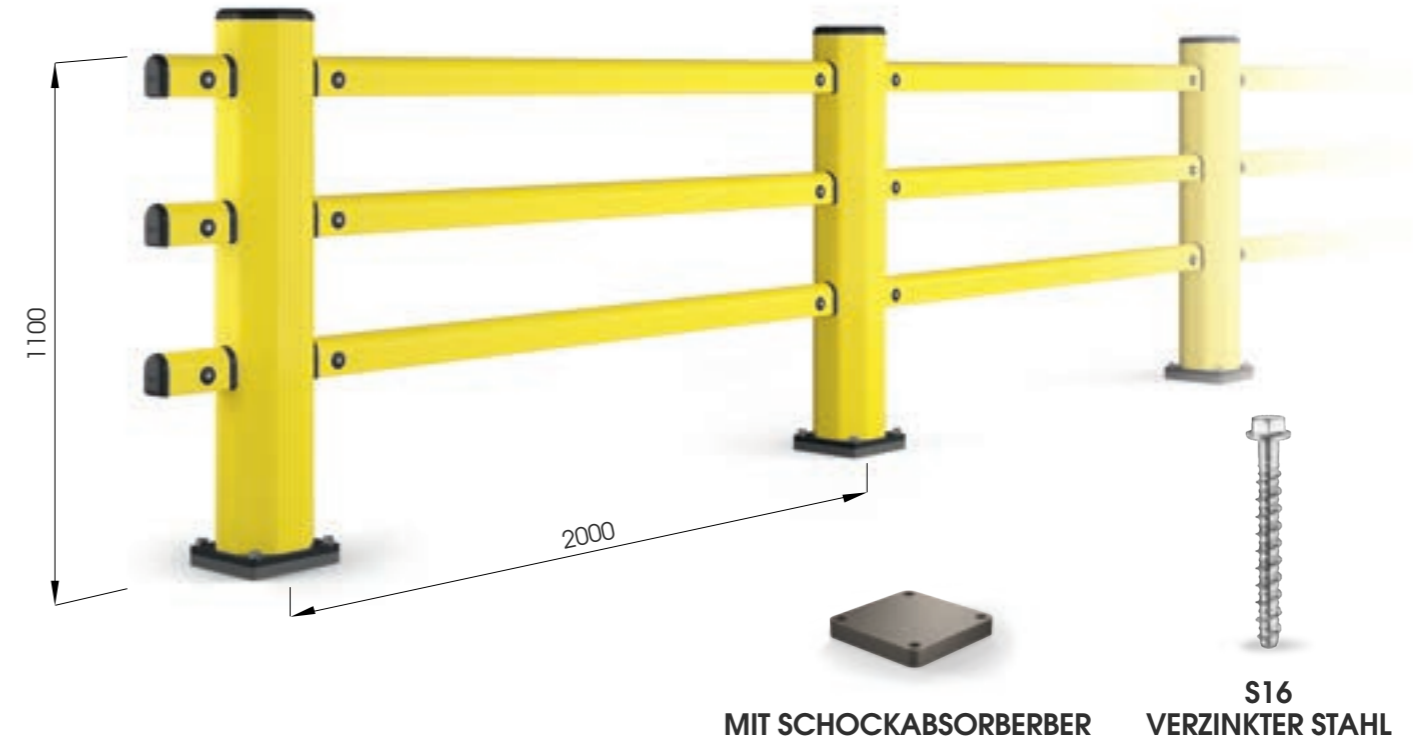

MIT SCHOCKABSORBERBER

**S16
VERZINKTER STAHL**

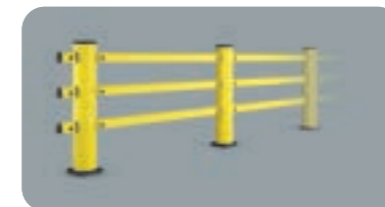

**PED 200 PIN
2000x1200**

inkl. Befestigungsmaterial

VPE
Farde

gewünschte Anzahl
M



07

SCHUTZ VON TÜREN UND TOREN

Sicherheitstore
als Zubehör von
Verkehrswegen;
je nach Platz mit
horizontaler oder
vertikaler Öffnung;
schnelle und einfache
Installation.

Sistema di cancelli di sicurezza ideati
per completare le nostre barriere di
protezione per aree pedonali.
Progettati seguendo un innovativo disegno
tecnico che coniuga rapidità e semplicità
nelle fasi di installazione e pulizia.
Disponibili molteplici sistemi di apertura.

Système de portillons résistant
aux chocs étudié pour
l'installation de nos barrières
de protections pour les zones
piétons. Portillons conçus suivant
un design innovant qui combine
rapidité et simplicité pendant
le montage et le nettoyage.
Différents systèmes d'ouvertures
disponibles.

Sistema de puertas diseñado
para completar nuestras
barreras peatonales.
Diseñado según un diseño
técnico innovador que
permite una instalación
rápida y sencilla.
Están disponibles varios
sistemas de apertura.

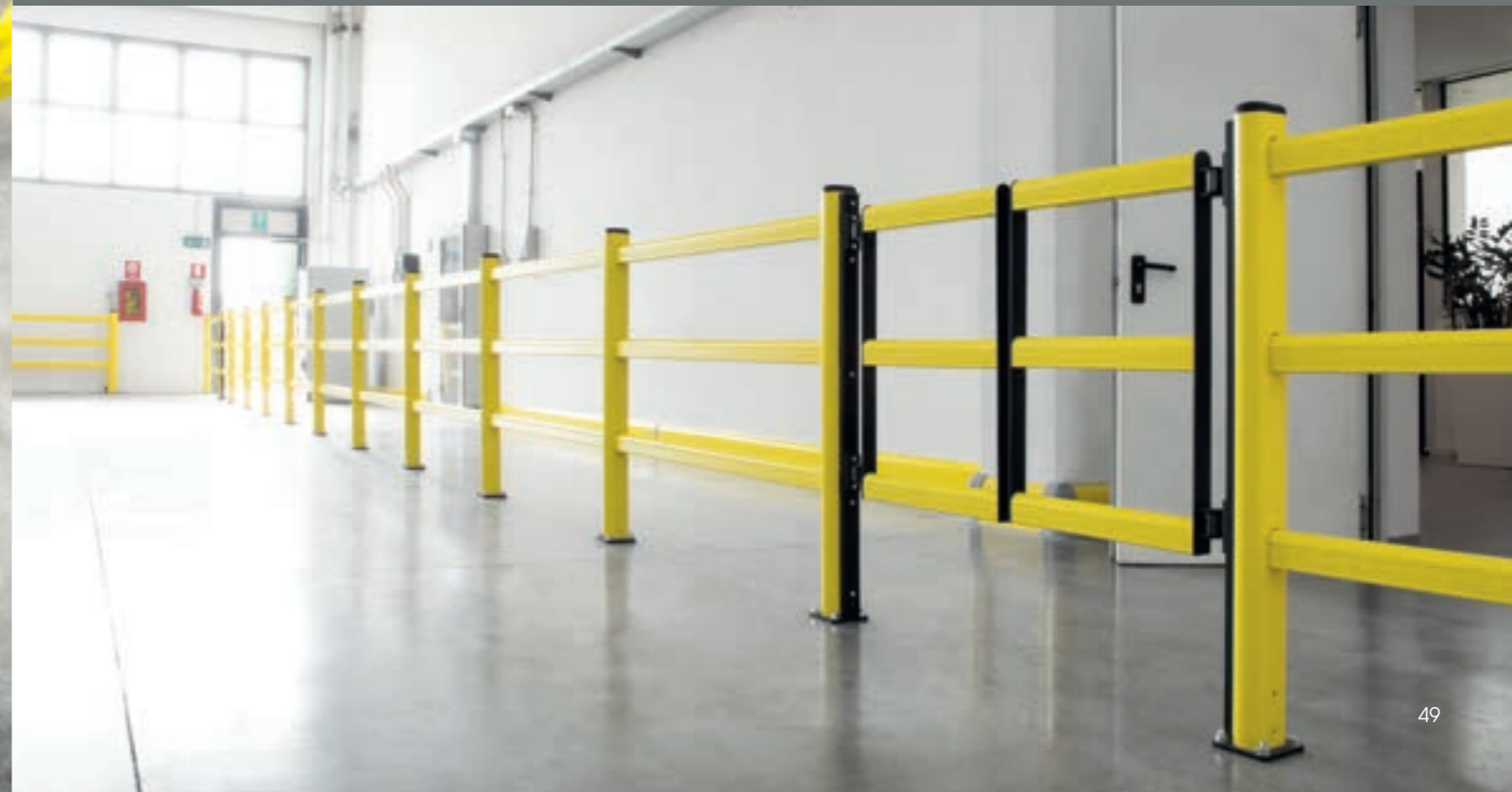

DOOR PEDESTRIAN 90

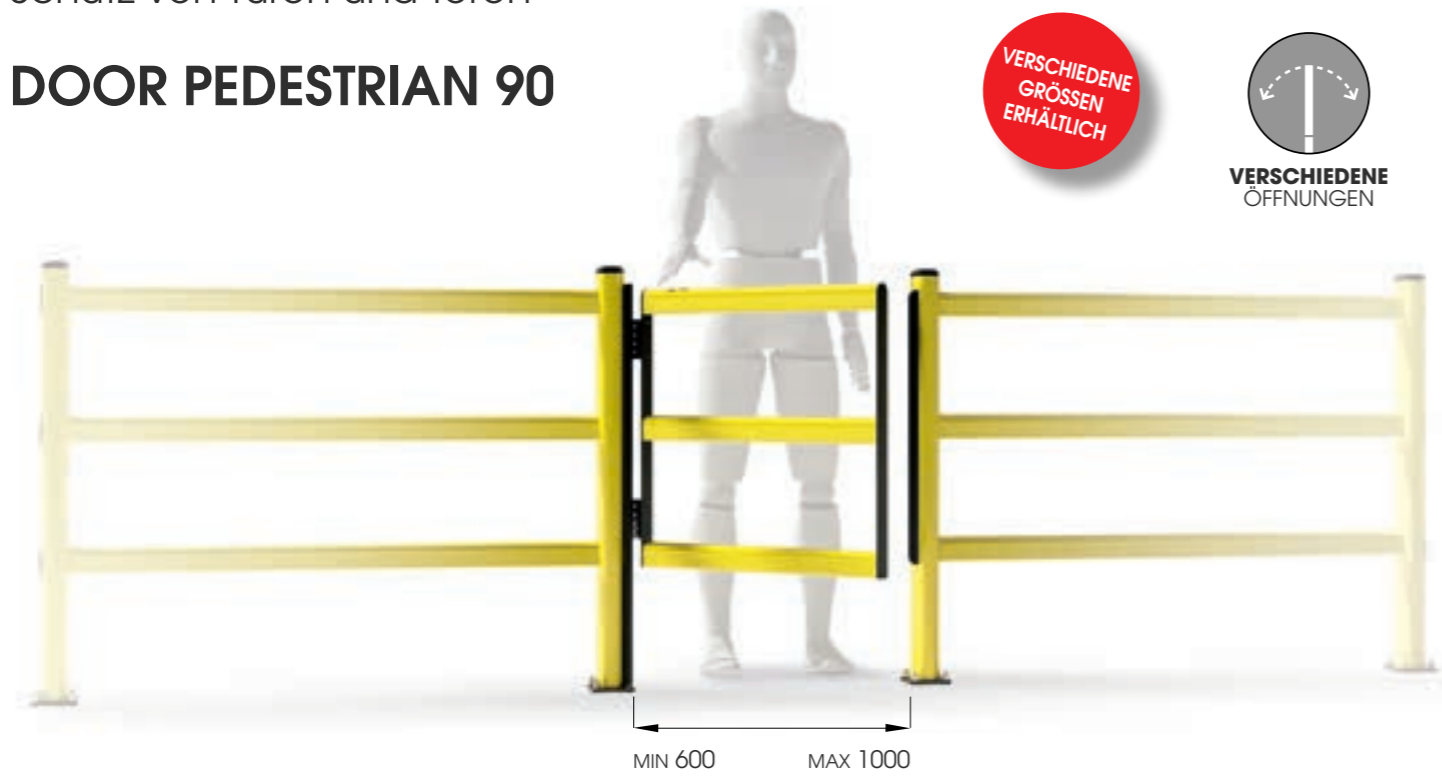

DP 90 ONE WAY

VPE
Farbe

gewünschte Anzahl
M P



inkl. Befestigungsmaterial



DP 90 SWING

VPE
Farbe

gewünschte Anzahl
M P



inkl. Befestigungsmaterial

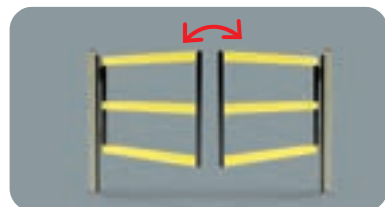

DP 90 SWING DOUBLE

VPE
Farbe

gewünschte Anzahl
M P

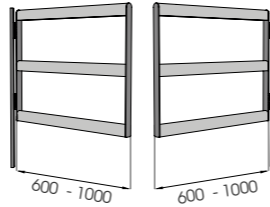

inkl. Befestigungsmaterial



DOOR PEDESTRIAN 150

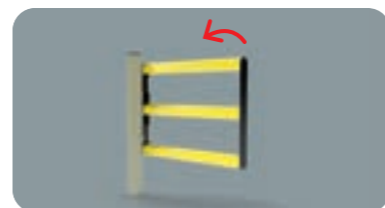
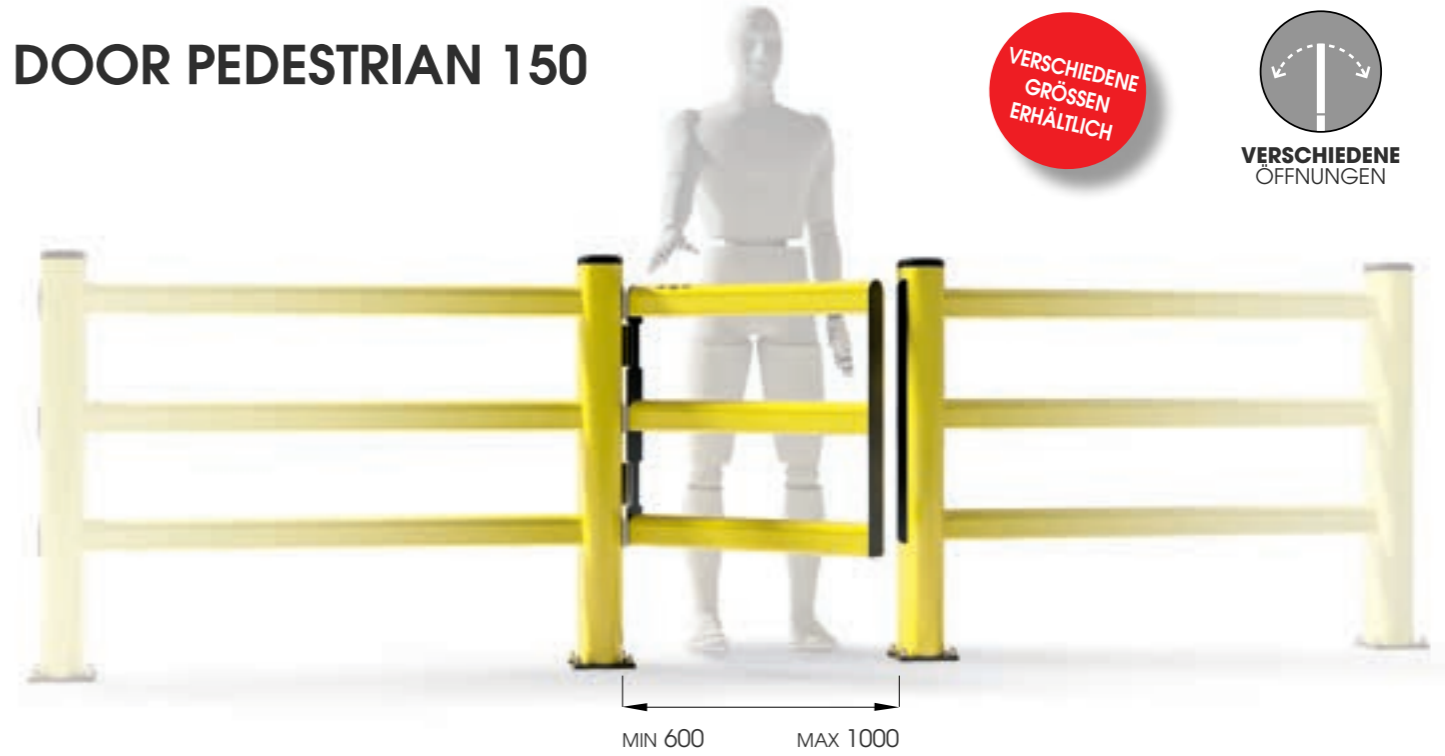

DP 150 ONE WAY

VPE
Farbe

gewünschte Anzahl
M P

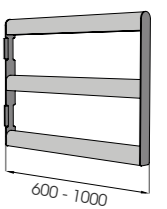

inkl. Befestigungsmaterial

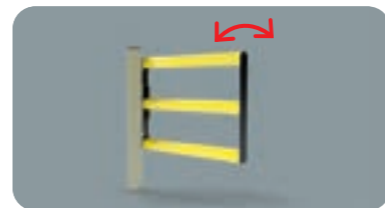

DP 150 SWING

VPE
Farbe

gewünschte Anzahl
M P

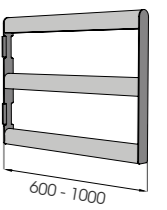

inkl. Befestigungsmaterial

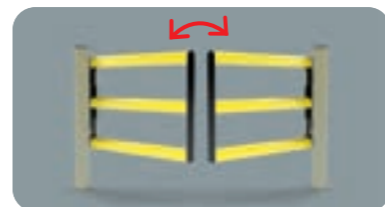

DP 150 SWING DOUBLE

VPE
Farbe

gewünschte Anzahl
M P

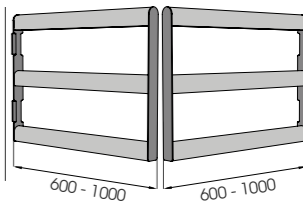

inkl. Befestigungsmaterial



LIFT GATE 90

VERSCHIEDENE GRÖSSEN ERHÄLTlich

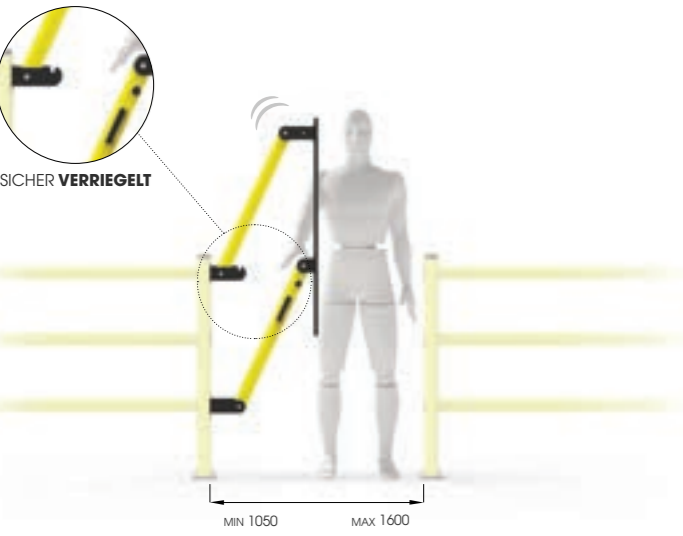

LIFT GATE 90 DOUBLE

x2
DOPPELTÜR

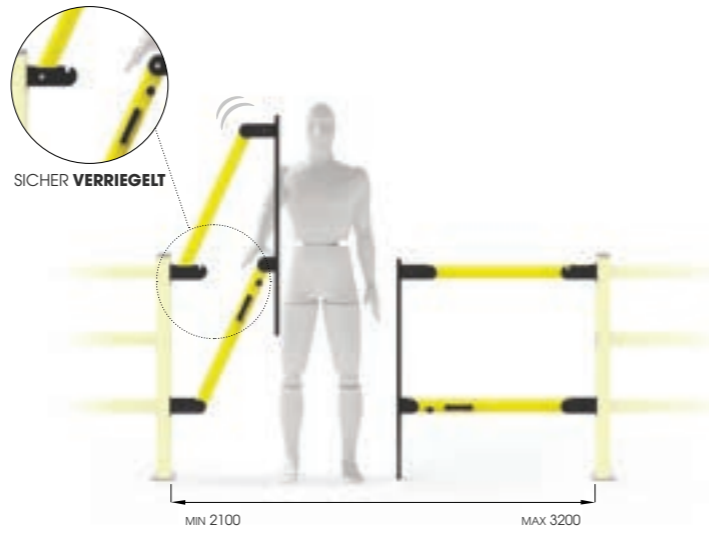

LIFT GATE 90

inkl. Befestigungsmaterial

VPE
Farbe

gewünschte Anzahl
M P

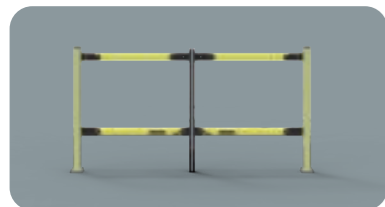

LIFT GATE 90 DOUBLE

inkl. Befestigungsmaterial

VPE
Farbe

gewünschte Anzahl
M P



LIFT GATE 150

VERSCHIEDENE GRÖSSEN ERHÄLTlich

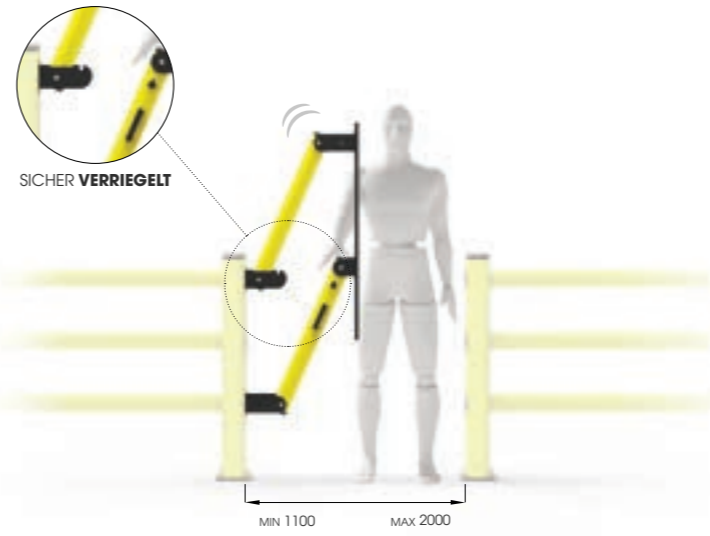

LIFT GATE 150 DOUBLE

x2
DOPPELTÜR

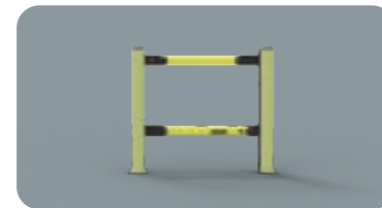
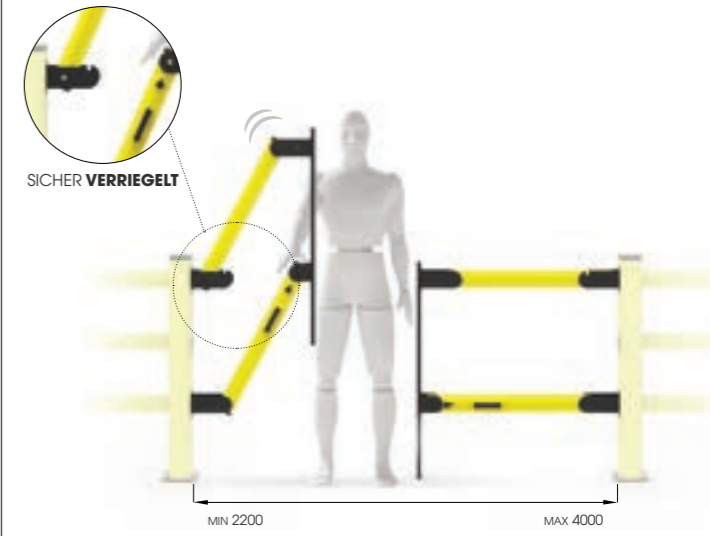

LIFT GATE 150

inkl. Befestigungsmaterial

VPE
Farbe

gewünschte Anzahl
M P

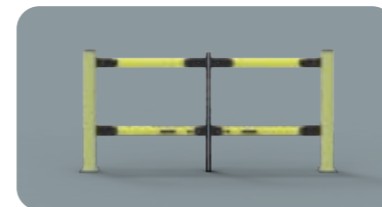

LIFT GATE 150 DOUBLE

inkl. Befestigungsmaterial

VPE
Farbe

gewünschte Anzahl
M P



08

SCHWERER ANFAHRSCHUTZ

Das weltweit erste System mit variabler Anpassung vor Ort; dank der neuen Link-Manschette jederzeit höhenverstellbar; wesentlich höhere Krafterfassung in allen Bereichen.

Prima barriera al mondo regolabile a piacimento con nuovo sistema di raccordo. Altezza regolabile, facilmente componibile, resistenza potenziata nei punti più critici.

Première barrière au monde à modifier aux besoins avec un nouveau système de jonction. Hauteur à changer, facile à assembler et résistance renforcée aux points plus compliqués.

Primera barrera ajustable en el mundo gracias a un nuevo sistema de conexión. Altura ajustable, de fácil modularidad y resistencia potenciada en los puntos más críticos.



**HÖHE
VARIABLE**

↕

**FÜR IHRE
ANFORDERUNGEN**

Schwerer Anfahrerschutz

LINK 150/3



VERSCHIEDENE
GRÖSSEN
ERHÄLTlich



M12
VERZINKTER STAHL

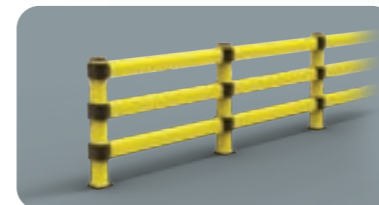

LINK 150/3

VPE
Farbe

gewünschte Anzahl
B M

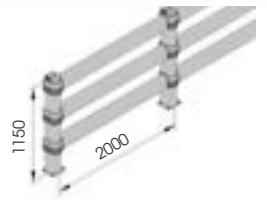

inkl. Befestigungsmaterial



LINK 150/3
CORNER

VPE
Farbe

gewünschte Anzahl
B M



Ecklösungen Erhältlich

inkl. Befestigungsmaterial



LINK 150/2



M12
VERZINKTER STAHL

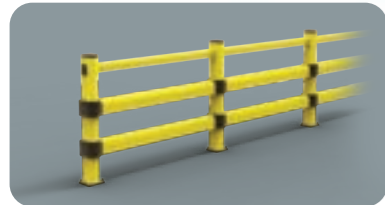

LINK 150/2

VPE
Farde

gewünschte Anzahl
B M



inkl. Befestigungsmaterial

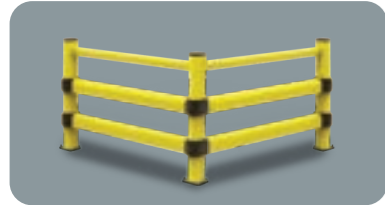

LINK 150/2
CORNER

VPE
Farde

gewünschte Anzahl
B M

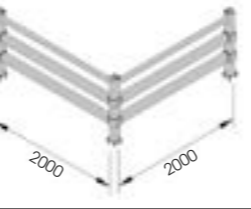

Ecklösungen Erhältlich

inkl. Befestigungsmaterial



LINK 150/1

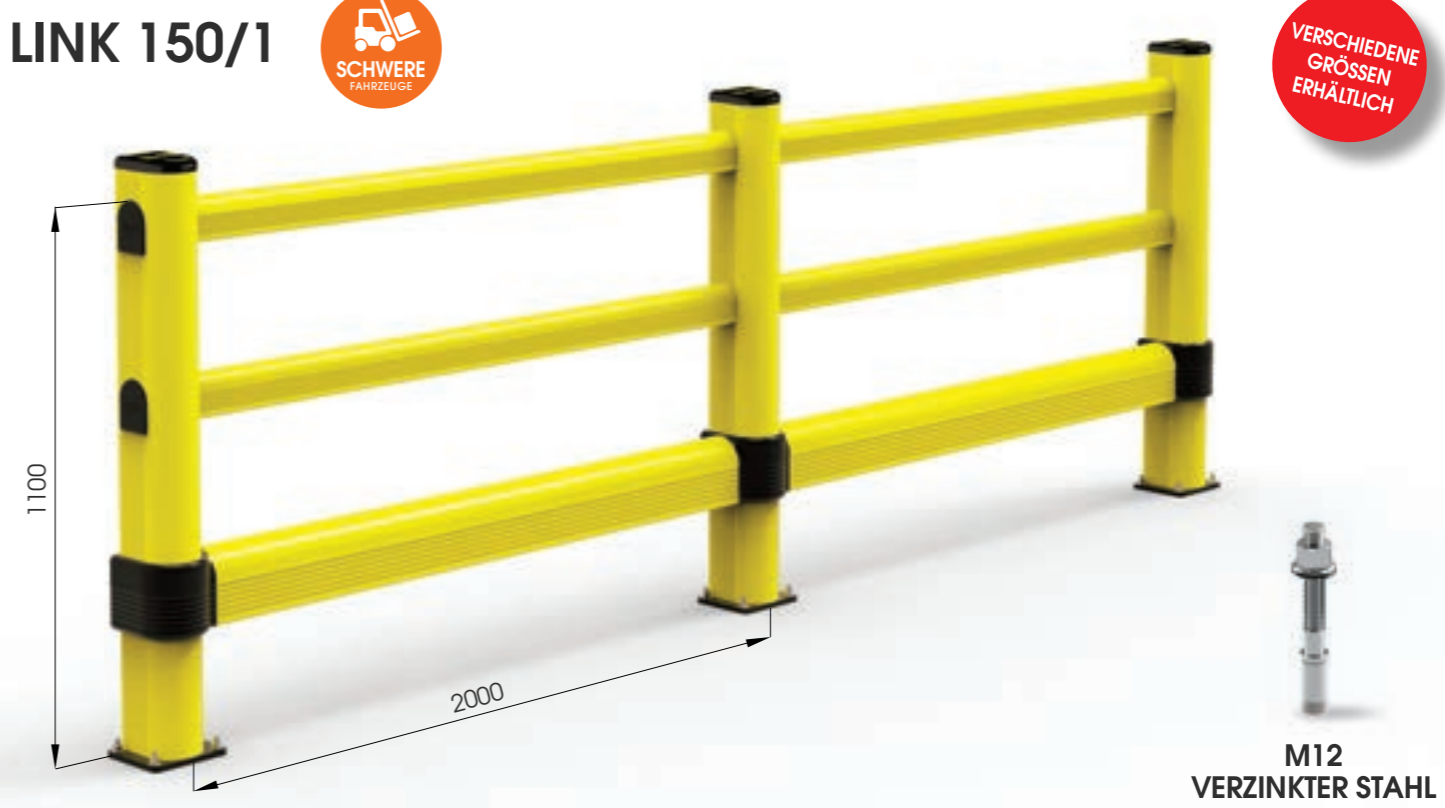

M12
VERZINKTER STAHL



LINK 150/1

VPE
Farde

gewünschte Anzahl
B M



inkl. Befestigungsmaterial

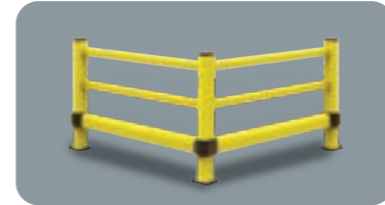

LINK 150/1
CORNER

VPE
Farde

gewünschte Anzahl
B M

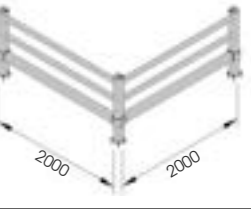

Ecklösungen Erhältlich

inkl. Befestigungsmaterial



LINK LM



VERSCHIEDENE GRÖSSEN ERHÄLTlich

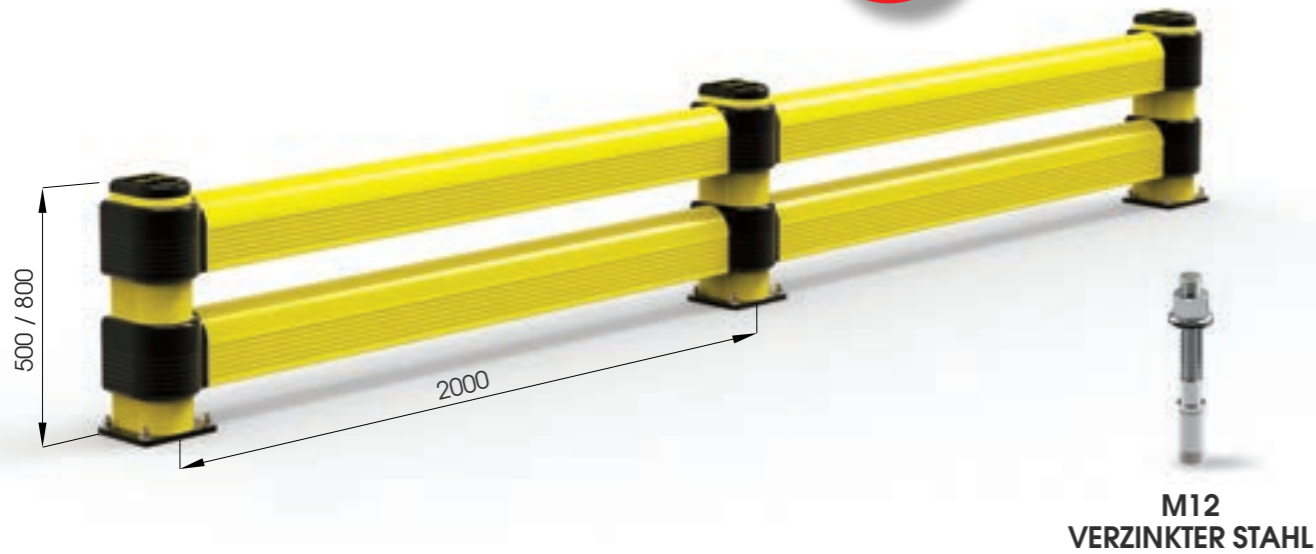

LINK SINGLE



VERSCHIEDENE GRÖSSEN ERHÄLTlich

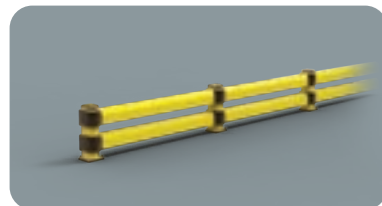
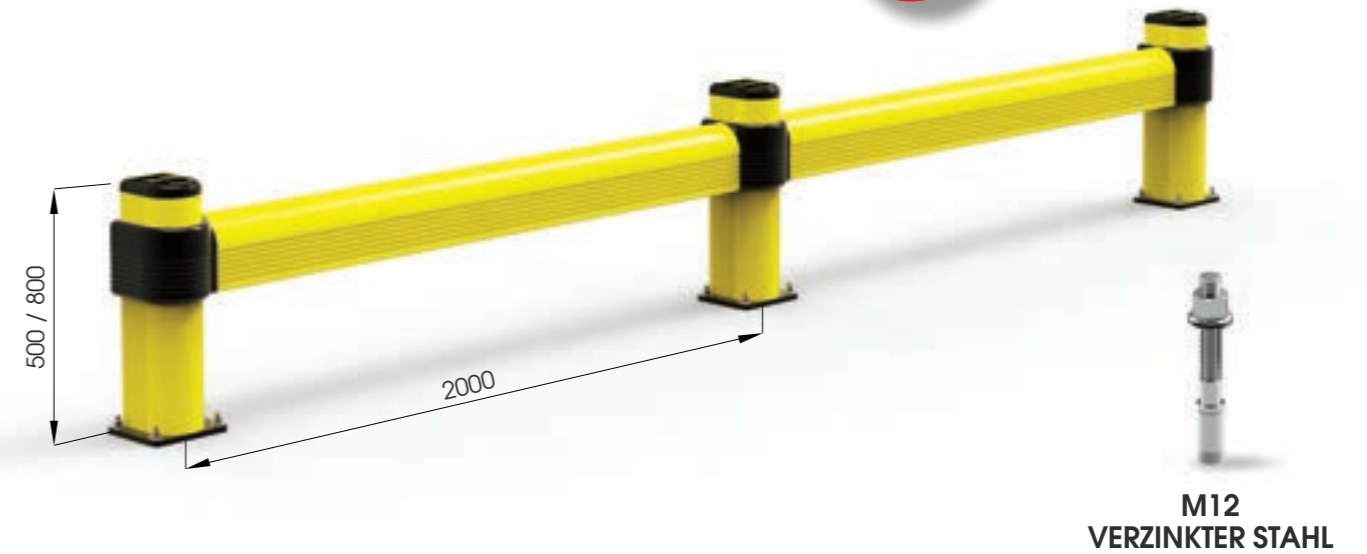

LINK LM 500
800

VPE
Farbe

gewünschte Anzahl
B M

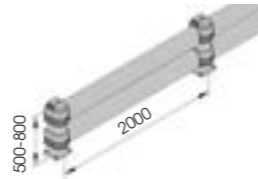

inkl. Befestigungsmaterial



LINK LM
CORNER

VPE
Farbe

gewünschte Anzahl
B M

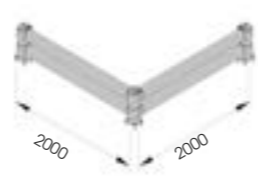

Ecklösungen Erhältlich

inkl. Befestigungsmaterial

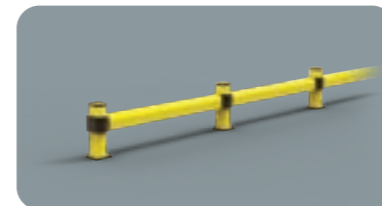

LINK SINGLE 500
800

VPE
Farbe

gewünschte Anzahl
B M



inkl. Befestigungsmaterial



LINK SINGLE
CORNER

VPE
Farbe

gewünschte Anzahl
B M

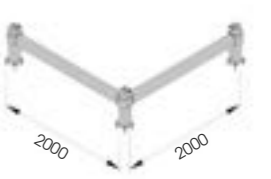

Ecklösungen Erhältlich

inkl. Befestigungsmaterial



COVER 90 RE

FÜR DEN SCHUTZ VON:
SM / FENCE 90
HR 90 / PED 90



1



2

COVER 150 RE

FÜR DEN SCHUTZ VON:
LINK / LM
FENCE 150
PED 150

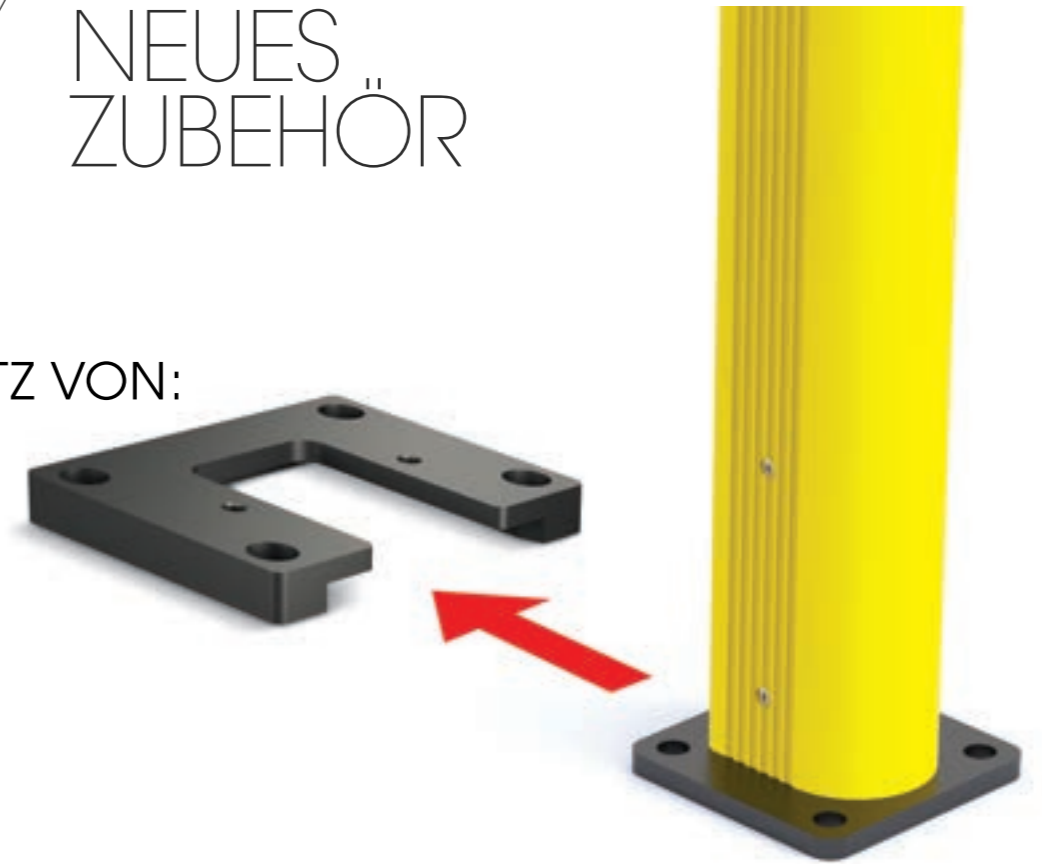

3



4

09

Ein neues Schutzsystem mit verstärkten Profilen. Äußerst starker Anfahrerschutz mit minimalem Platzbedarf. Erhältlich in verschiedenen Varianten.

BFLEX

Nuovo sistema di protezioni con profilo rinforzato, doppiamente flessibile e assorbente. Progettato e realizzato con un particolare design per garantire alti livelli di sicurezza e resistere all'impatto da carichi pesanti. Disponibile in diverse versioni.

Nouveau système de protection avec profil renforcé, doublement flexible et absorbant. Conçu et produit avec un design particulier pour assurer des niveaux élevés de sécurité et résister à l'impact des charges lourdes. Disponible en plusieurs versions.

Nuevo sistema de protección con perfil reforzado, más flexible y capaz de absorber perfectamente los impactos. Diseñado para asegurar el entorno laboral y para resistir a los impactos de cargas pesadas. Disponible en diferentes versiones.



Für Hygienebereiche geeignet

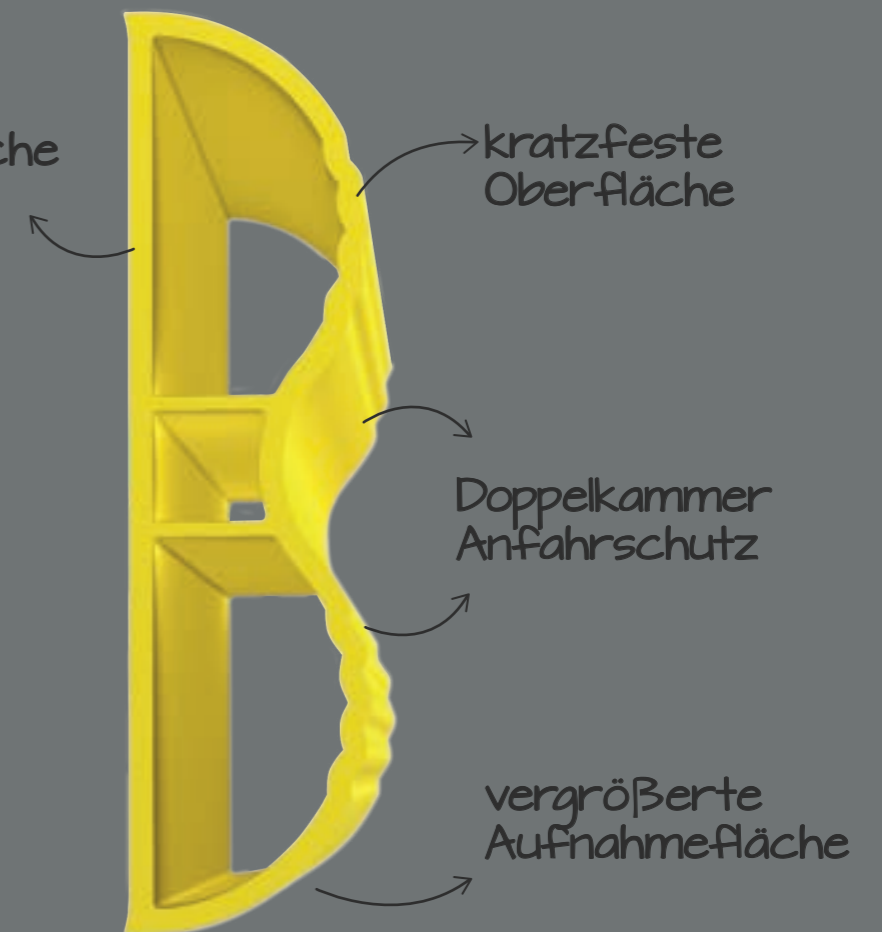

BFLEX.FRONT/1



BFLEX.FRONT/1 1100x450
BFLEX.FRONT/1 2400x450

Länge 1.100 / 2.400 mm
VPE gewünschte Anzahl
Farbe **M**

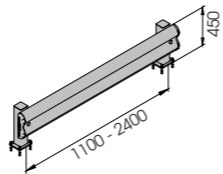

inkl. Befestigungsmaterial



BFLEX.FRONT/1 2000x450 MODULAR

VPE gewünschte Anzahl
Farbe **M**

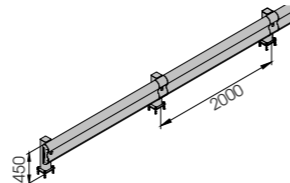

inkl. Befestigungsmaterial



BFLEX.FRONT/2

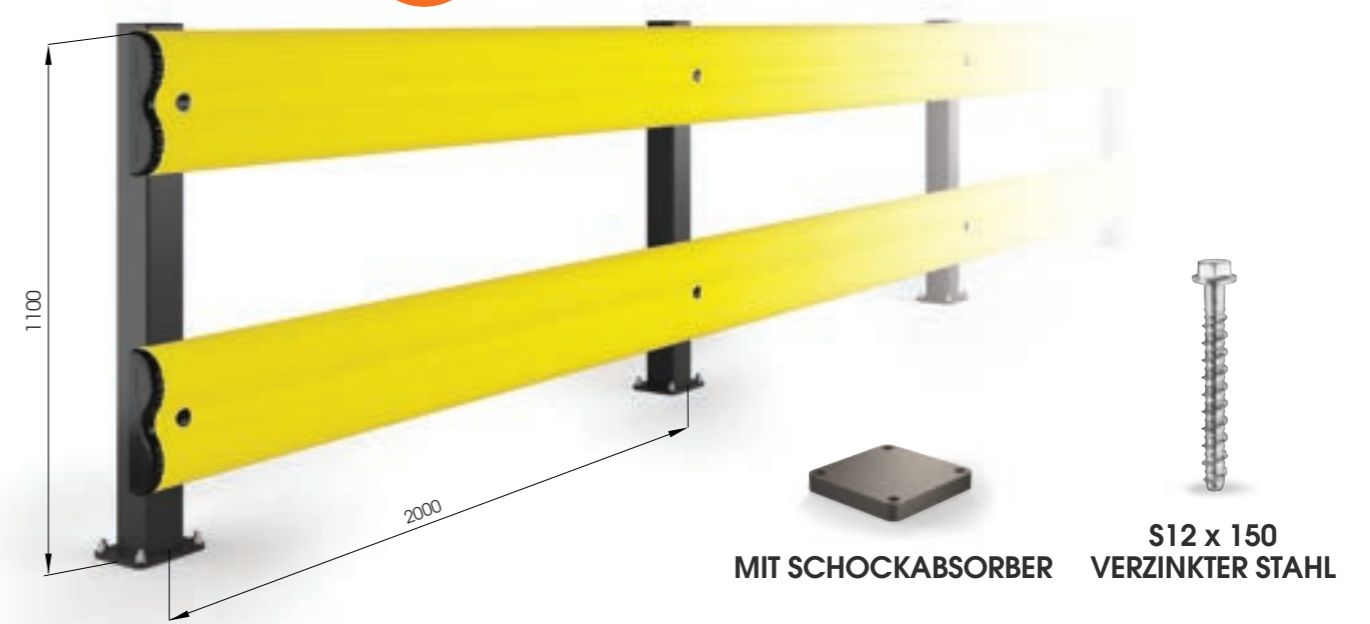

BFLEX.FRONT/2 1100x1100
BFLEX.FRONT/2 2400x1100

Länge 1.100 / 2.400 mm
VPE gewünschte Anzahl
Farbe **M**

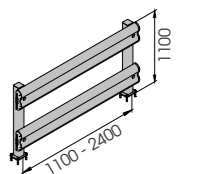

inkl. Befestigungsmaterial



BFLEX.FRONT/2 2000x1100 MODULAR

VPE gewünschte Anzahl
Farbe **M**

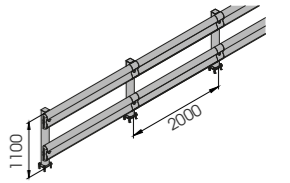

inkl. Befestigungsmaterial



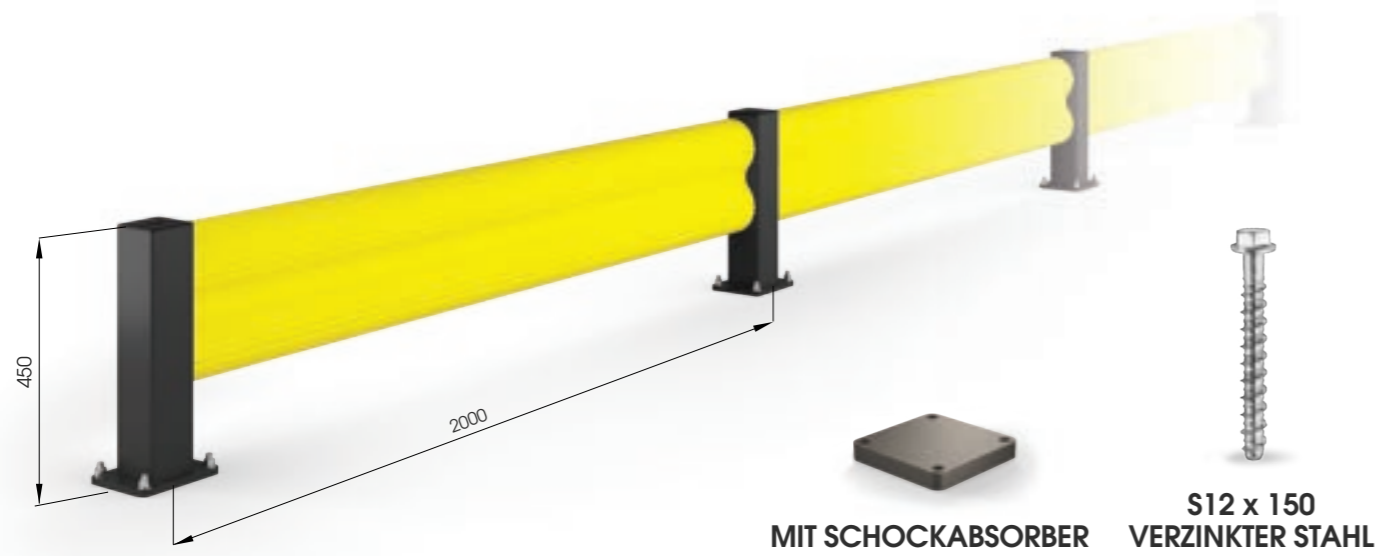

MIT SCHOCKABSORBER
S12 x 150
VERZINKTER STAHL



BFLEX.COM/1 1100x450
BFLEX.COM/1 2400x450

Länge 1.100 / 2.400 mm
VPE gewünschte Anzahl
Farbe M

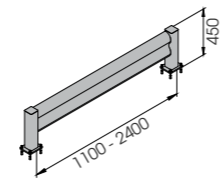

inkl. Befestigungsmaterial



BFLEX.COM/1 2000x450
MODULAR

AUCH ALS ECKLÖSUNG

inkl. Befestigungsmaterial

VPE gewünschte Anzahl
Farbe M

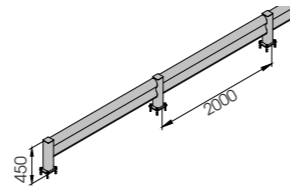

MIT SCHOCKABSORBER
S12 x 150
VERZINKTER STAHL



BFLEX.COM/2 1100x1100
BFLEX.COM/2 2400x1100

Länge 1.100 / 2.400 mm
VPE gewünschte Anzahl
Farbe M

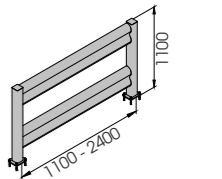

inkl. Befestigungsmaterial



BFLEX.COM/2 2000x1100
MODULAR

AUCH ALS ECKLÖSUNG

inkl. Befestigungsmaterial

VPE gewünschte Anzahl
Farbe M

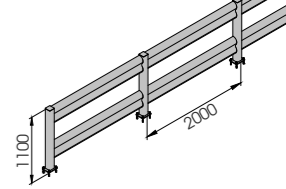

10 SÄULENSCHUTZ

Das neue System zum Schutz von Säulen aller Art; erhältlich in verschiedenen Höhen und Größen; für leichten und schweren Verkehr geeignet; ansprechendes Industriedesign; schnelles und einfaches Reinigen und Installieren.

Sistema di profili specifico per la protezione delle colonne dai carrelli in movimento di varie portate. Progettato seguendo un innovativo disegno tecnico che coniuga rapidità e semplicità nelle fasi di installazione e pulizia. Disponibile in diverse altezze e tipologie di fissaggio.

Nouveau système bumper, spécifique pour protéger les poteaux contre les mouvements des chariots. Étudié avec un modern dessin qui regroupe la rapidité et la facilité pendant l'installation et le nettoyage. Disponible en différents hauteurs et différents fixations.

Sistema de perfiles específico para la protección de las columnas de los carros en movimiento de diferentes capacidades. Diseñado según un innovador diseño técnico que une velocidad y simplicidad en las fases de instalación y limpieza. Disponible en diferentes alturas y tipos de fijación.



- EINFACHE INSTALLATION
- SCHLANKES DESIGN
- HOHE KRAFTAUFNAHME
- NICHT AN DER SÄULE FIXIERT

MINI HUG TOWER

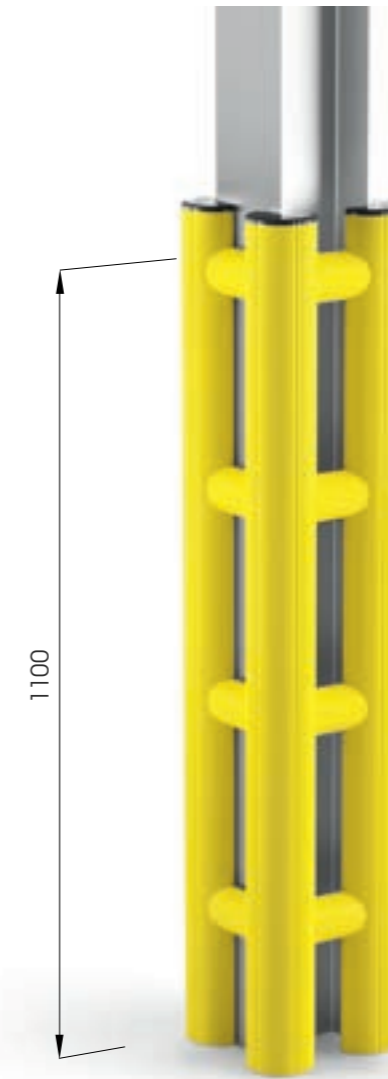

Säulenschutz

VERSCHIEDENE
GRÖSSEN AUF
ANFRAGE

EINFACHE
INSTALLATION



KEINE BOHRUNGEN
IN BODEN ODER SÄULE!



MINI HUG TOWER

VPE
Farbe

gewünschte Anzahl
M

inkl. Befestigungsmaterial

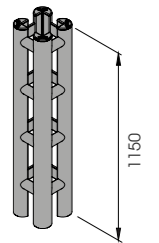

HUG TOWER 3 SIDES



VERSCHIEDENE GRÖSSEN ERHÄLTICH



WANDBEFESTIGUNG MIT S8 AUS GALVANISIERTEM STAHL

EINFACHE INSTALLATION



KEINE BOHRUNGEN IN BODEN ODER SÄULE!

METALLKLAMMER

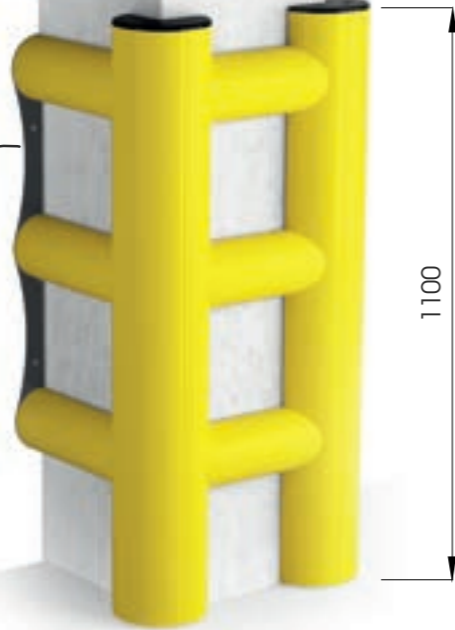

HUG TOWER



VERSCHIEDENE GRÖSSEN AUF ANFRAGE

EINFACHE INSTALLATION



KEINE BOHRUNGEN IN BODEN ODER SÄULE!

HÖHE NACH IHREN ANSPRÜCHEN!

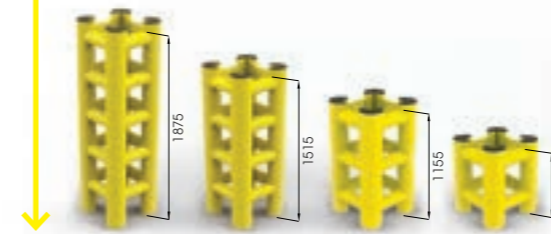

1100

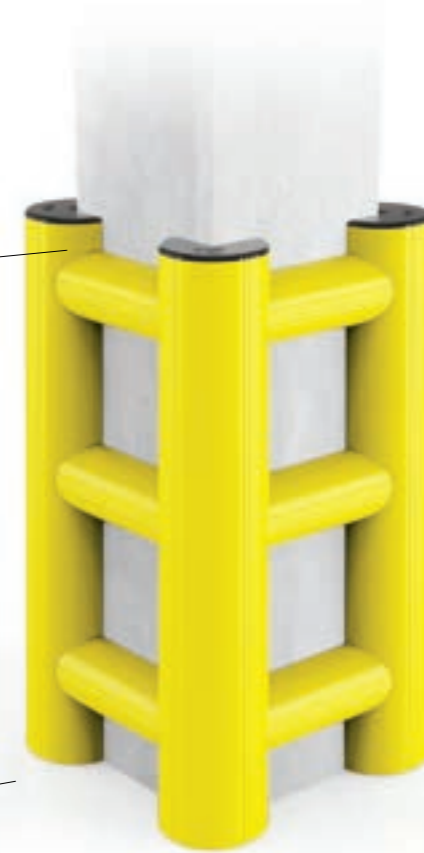

HUG TOWER 3 SIDES

auch 2-seitig verfügbar

inkl. Befestigungsmaterial

VPE Farde

gewünschte Anzahl **M**



HUG TOWER

inkl. Befestigungsmaterial

VPE Farde

gewünschte Anzahl **M**



TOWER PROTECTION



VERSCHIEDENE GRÖSSEN AUF ANFRAGE



M12 VERZINKTER STAHL

Auch erhältlich:

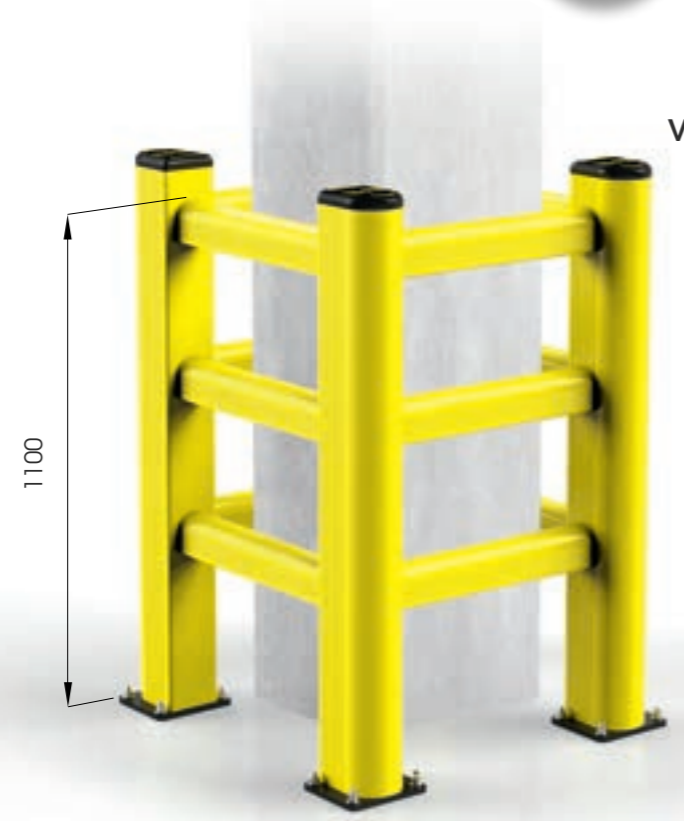
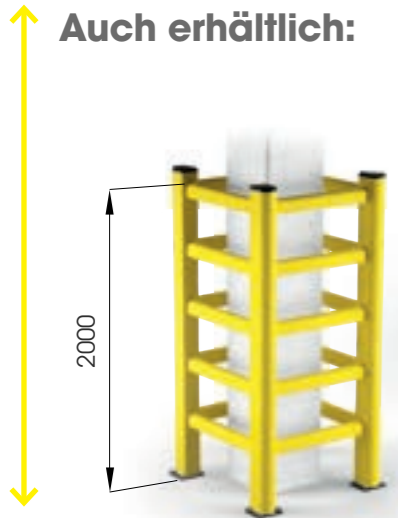

TOWER

auch 2/3-seitig verfügbar

inkl. Befestigungsmaterial

VPE Farde

gewünschte Anzahl
B M



TOWER LINK



VERSCHIEDENE GRÖSSEN AUF ANFRAGE



M12 VERZINKTER STAHL

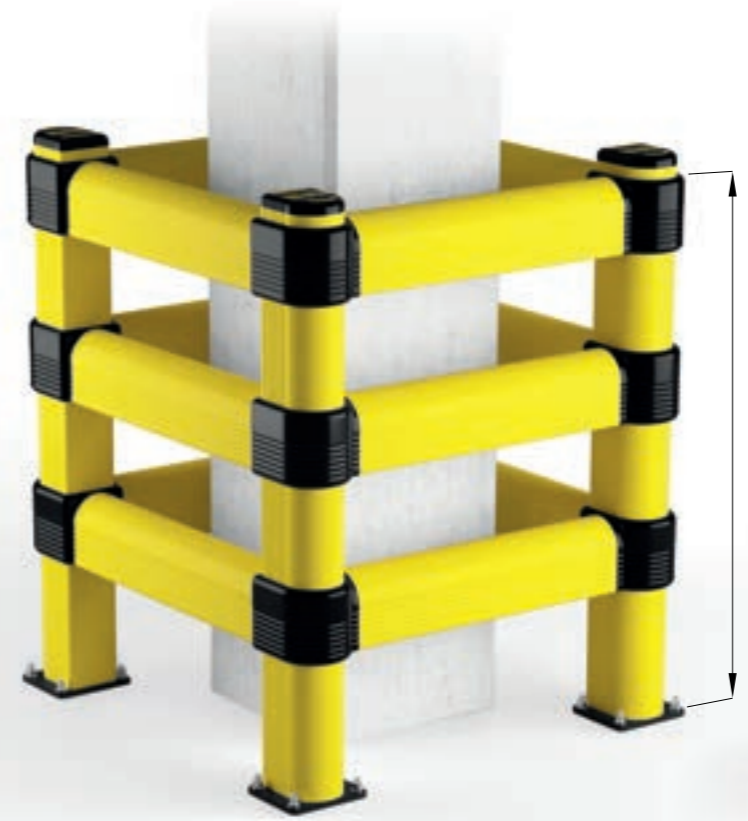

1100

weitere Modelle



TOWER LINK/1

TOWER LINK/2

TOWER LINK/3



TOWER LINK/1
TOWER LINK/2
TOWER LINK/3

inkl. Befestigungsmaterial

VPE Farde

gewünschte Anzahl
B M

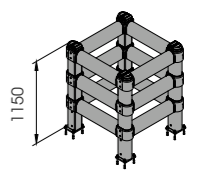

COLUMN PROTECTION 90



VERSCHIEDENE GRÖSSEN ERHÄLTICH

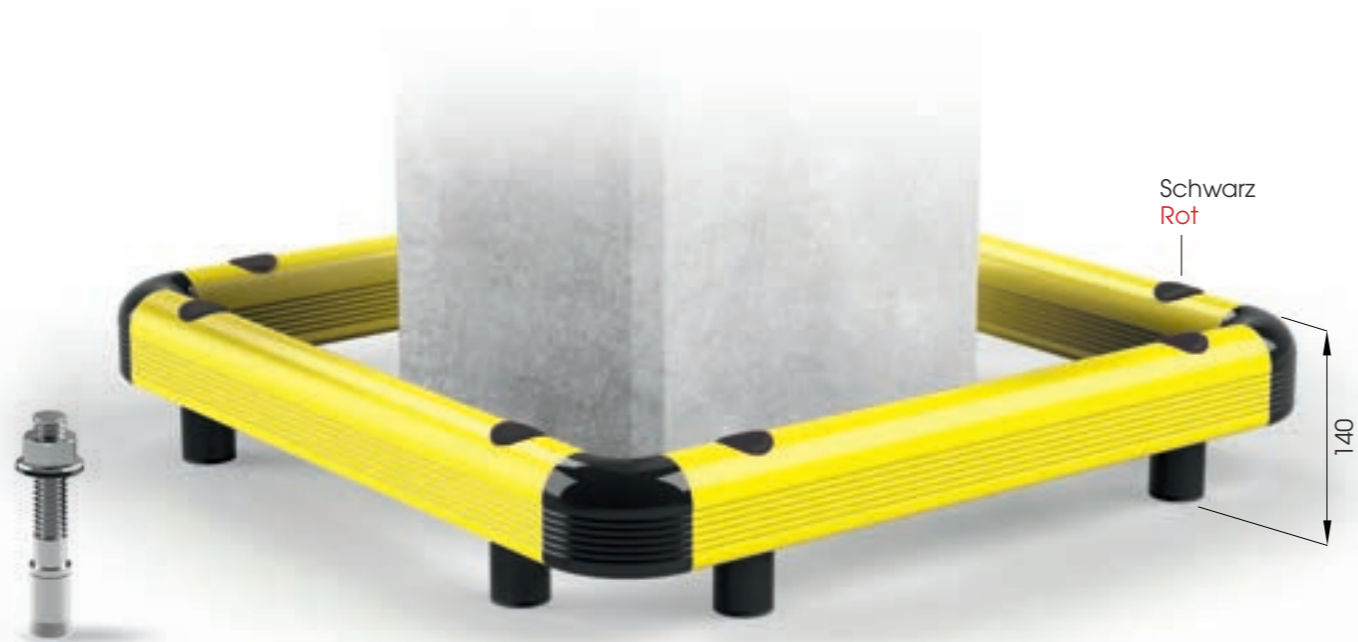

M16
EDELSTAHL



COPRO 90

auch 2/3-seitig verfügbar

inkl. Befestigungsmaterial

VPE
Farbe

gewünschte Anzahl
B M



COLUMN PROTECTION 150



VERSCHIEDENE GRÖSSEN ERHÄLTICH

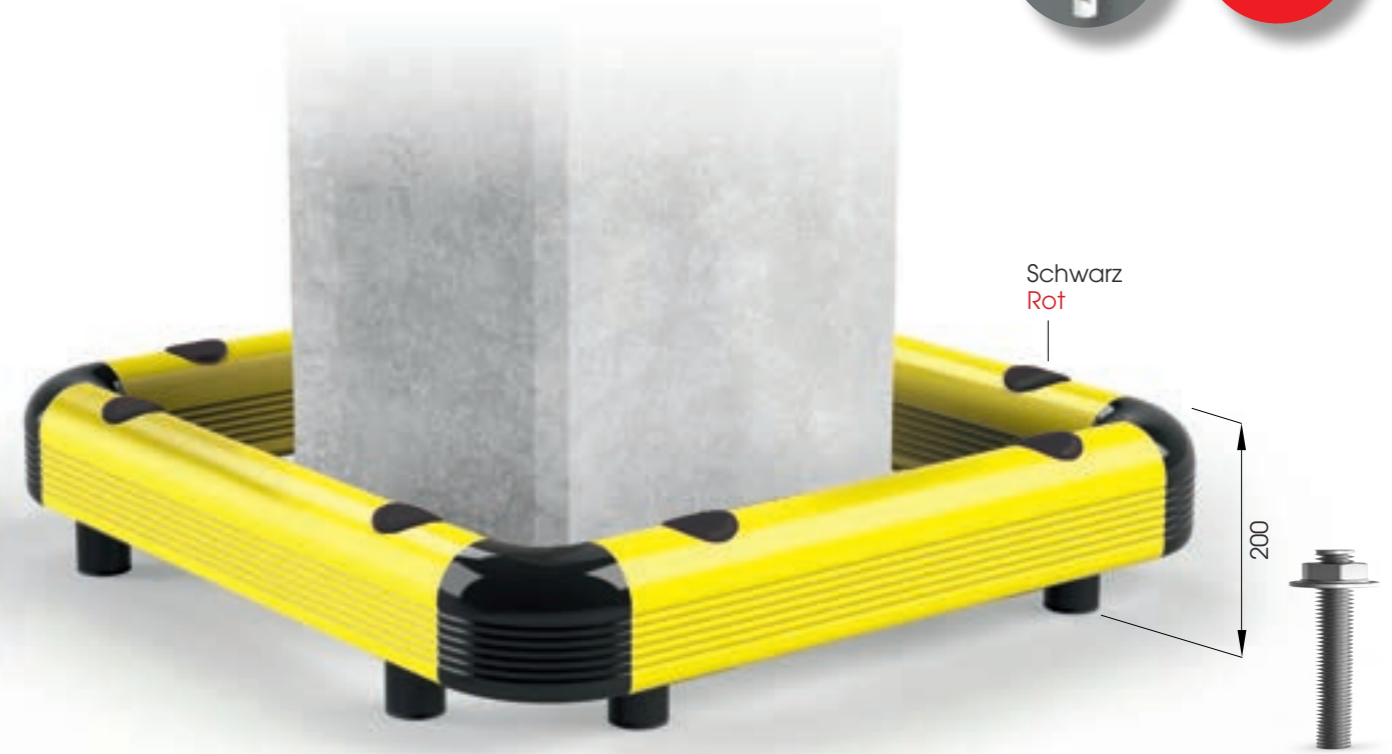

SF20
EDELSTAHL



COPRO 150

auch 2/3-seitig verfügbar

inkl. Befestigungsmaterial

VPE
Farbe

gewünschte Anzahl
B M

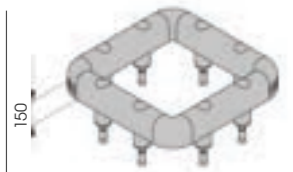

HÖHENBEGRENZER

Systèmes de protection conçus pour prévenir les collisions des chariots élévateurs en mouvement avec les infrastructures en hauteur et les montants des portes. Utiles pour empêcher le passage des chariots élévateurs qui dépassent les limites d'hauteur, pour attirer l'attention des conducteurs et de les habituer à faire plus attention à la conduite des chariots. C'est installé en proximité des bords des portes, quais de chargement et infrastructures suspendues. Disponible en plusieurs longueurs.

Sistema de protección diseñado para evitar la colisión de carretillas elevadoras en movimiento con infraestructuras, instalaciones elevadas y marcos de puertas industriales. Diseñada para limitar el paso de las carretillas que superan los límites de altura, llamando la atención de los conductores de montacargas e invitándoles a conducir con más cuidado. Se recomienda su instalación cerca de puertas industriales, muelles de carga o equipos suspendidos. Disponible en varias longitudes.

Entwickelt um Tore, Rahmen und unter der Decke montierte Gebäudebestandteile vor hochstehenden Gabeln zu schützen. Staperfahrer werden optisch und akustisch auf mögliche Gefahren hingewiesen.

Sistema di protezione ideato per prevenire le collisioni dei carrelli elevatori in movimento con le infrastrutture sopraelevate e gli stipiti di porte e portoni. Limita il passaggio di carrelli che superano i limiti di altezza, attirando l'attenzione dei carrellisti e invitandoli ad una guida più accorta. L'installazione è consigliata in prossimità di portoni, baie di carico o di attrezzature sospese. Disponibile in diverse lunghezze.

WARNING BAR



WBAR

Länge 2000 / 3000 mm
VPE gewünschte Anzahl
Farbe M

inkl. Befestigungsmaterial

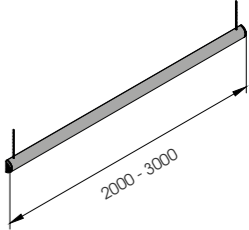

WARNING BAR / INFORMATION SIGN



WBIS

Length 2000 / 3000 mm
VPE gewünschte Anzahl
Farbe M

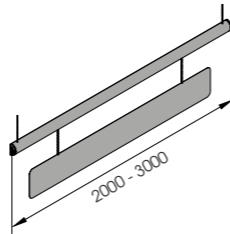

inkl. Befestigungsmaterial

WARNING BAR / LIGHT & SOUND

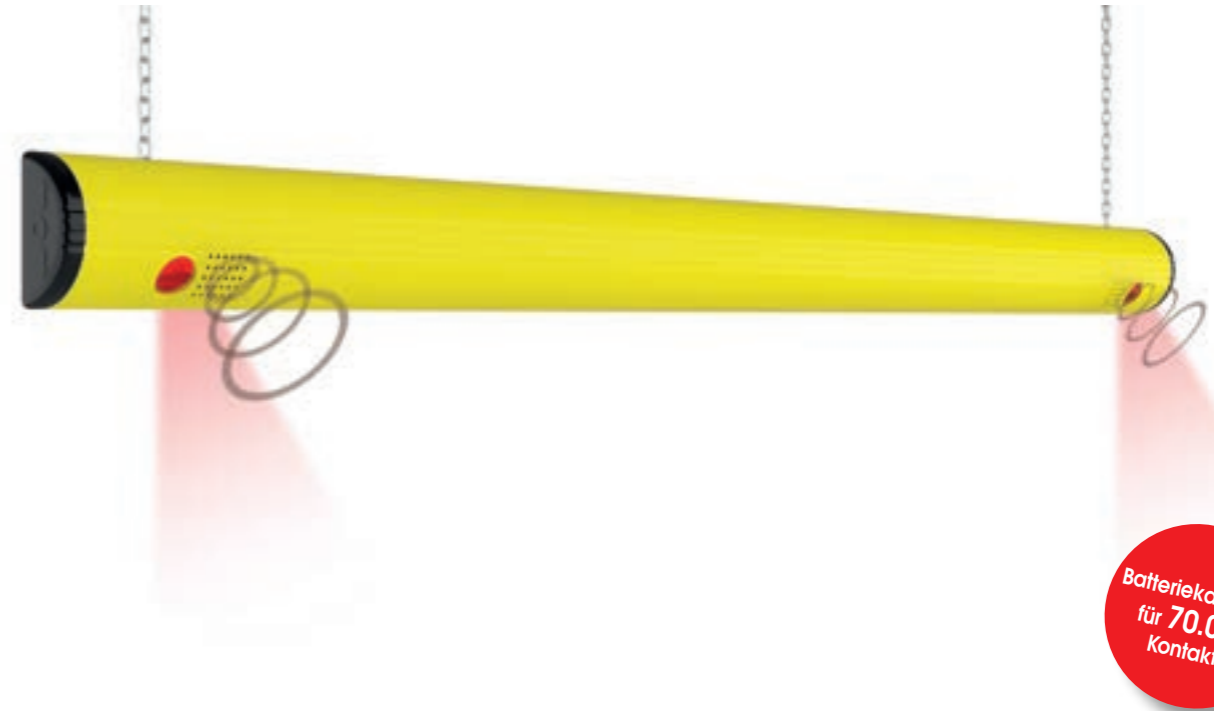

Batteriekapazität für 70.000 Kontakte



WBLS

Karabiner und Ketten enthalten

Length 2000 / 3000 mm
VPE gewünschte Anzahl
Farbe M

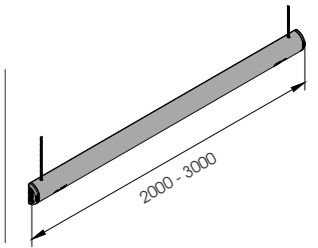

inkl. Befestigungsmaterial



FULL FRAME SELF STANDING



VERSCHIEDENE GRÖSSEN ERHÄLTICH

SCHNELLE UND EINFACHE INSTALLATION

GRÖSSERE BODENPLATTEN

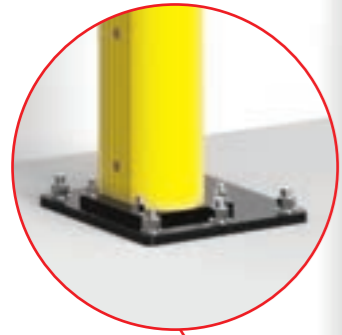

M16 VERZINKTER STAHL



FFB SELF STANDING

VPE Farbe

gewünschte Anzahl **M**

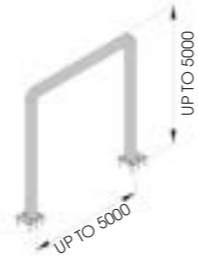

inkl. Befestigungsmaterial

FULL FRAME WALL FIXING



VERSCHIEDENE GRÖSSEN ERHÄLTICH

SCHNELLE UND EINFACHE INSTALLATION

BEFESTIGUNGSMATERIAL WAND

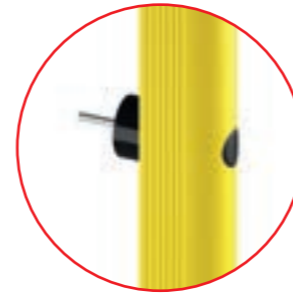

M12 VERZINKTER STAHL



FFB WALL FIXING

VPE Farbe

gewünschte Anzahl **M**



inkl. Befestigungsmaterial



12

ANFAHRSCHUTZ AN LADETOREN

Système de protection contre les chocs installé près des portes de chargement. Ils permettent d'éviter des situations en raison du risque élevé de glissement, de chute et de basculement des véhicules en mouvement en présence de quais de chargement ouverts et sans surveillance.

Sistema de protección antigolpes que está cerca de los muelles de carga. Evitan los riesgos de deslizamiento, caída y derrocamiento de los vehículos en movimiento cuando están cerca de esta zona.

Starker Rammschutz an stark frequentierten Ladetoren. Personen, Fahrzeuge und Ladung werden an geöffneten Toren zuverlässig geschützt.

Sistema di protezione antiurto installato in prossimità delle porte di carico. Permettono di evitare situazioni ad alto rischio di scivolamento, caduta e ribaltamento dei mezzi in movimento in presenza di baie di carico aperte e non presidiate.



NEU

DOCK BUMPER



Anfahrerschutz an Ladetoren



**S16
VERZINKTER STAHL**



DOCK BUMPER

VPE

gewünschte Anzahl

inkl. Befestigungsmaterial

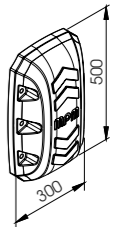

NEU

Anfahrtschutz an Ladetoren

HUG GATE



1



2



DRÜCKEN ZUM ENTRIEGELN



M12
VERZINKTER STAHL



HUG GATE

VPE
Farbe

gewünschte Anzahl
B M

inkl. Befestigungsmaterial



Anfahrtschutz an Ladetoren

DOCK GATE



M12
VERZINKTER STAHL



DOCK GATE L 2400-2600
DOCK GATE XL 2605-2800
DOCK GATE XXL 2805-3000

VPE
Farbe

gewünschte Anzahl
B M

inkl. Befestigungsmaterial

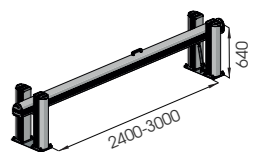

13

BARRIEREN FÜR FAHRZEUGE

SICHERHEITSSYSTEM FÜR das Rangieren auf PARKPLÄTZEN & IN LADEZONEN.

Soluzioni progettate per la sicurezza delle zone di carico e scarico dei magazzini e dei parcheggi. Ideali per convogliare, fermare o posizionare il mezzo nell'area di parcheggio o in prossimità di una baia di carico.

Solutions conçues pour la sécurité des zones de chargement et de déchargement des entrepôts et parkings. Idéal pour transporter, arrêter ou positionner le véhicule dans l'aire de stationnement ou à proximité d'un quai de chargement.

Soluciones diseñadas para asegurar las zonas de carga y descarga de almacenes y aparcamientos. Ideal para transportar, detener o posicionar el vehículo en la zona de aparcamiento o cerca de un muelle de carga.



TRUCK LINE



Barrieren für Fahrzeuge

VERSCHIEDENE GRÖSSEN ERHÄLTICH



SF20 x 200 EDELSTAHL



TL	500	2000
	750	3000
	1000	4000
	1500	

inkl. Befestigungsmaterial

VPE
Farbe

gewünschte Anzahl

B M



CAR STOP

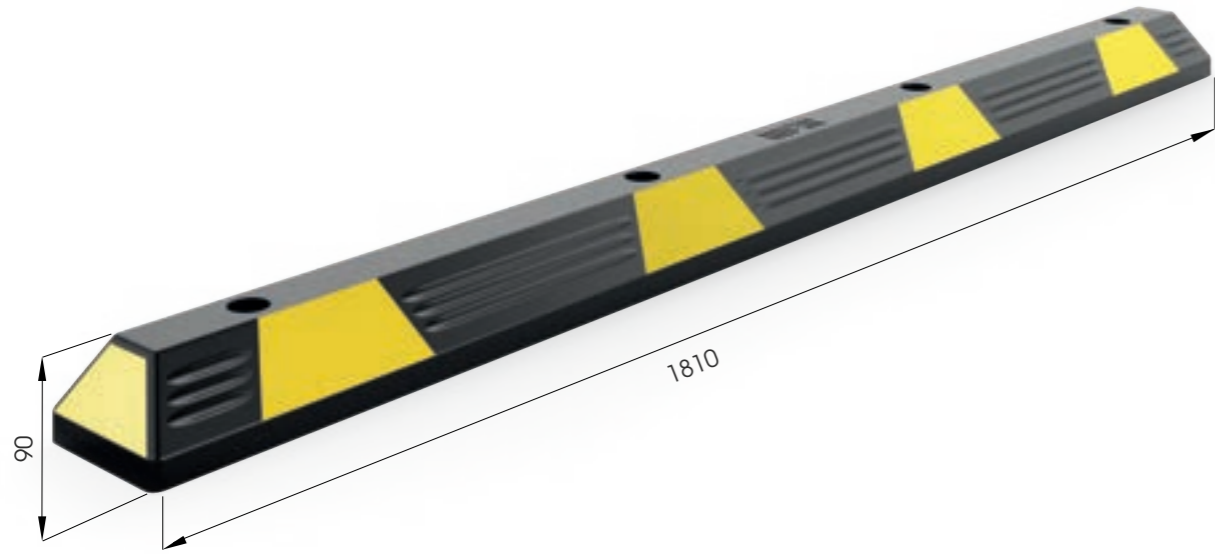

CAR STOP

VPE

gewünschte Anzahl

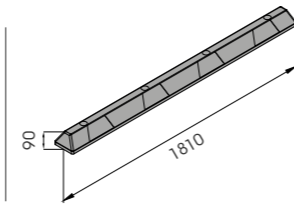

bei Bedarf mit Befestigungsmaterial

TRUCK STOP



TRUCK STOP

VPE

gewünschte Anzahl

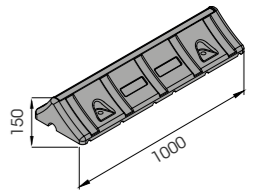

bei Bedarf mit Befestigungsmaterial



14

KABELABDECKUNG

Kabelabdeckung für den Boden aus weichem Material, einfach zu installieren. Geeignet für Bereiche mit Fußgängerverkehr.

Sistema di protezione morbido a pavimento per cavi, realizzato con materiale riciclato. Passacavi poco ingombrante, resistente e facile da posare. Adatto ad aree di lavoro con passaggio di pedoni.

Système de protection de sol souple pour câbles. Guide-câble peu encombrant, résistant et facile à installer. Convient aux zones de travail avec passage piéton.

Sistema de protección blando de suelo para los cables realizado con material reciclable. Pasacables que ahorra espacio, duradero y fácil de instalar. Adecuado para zonas de trabajo con tráfico peatonal.

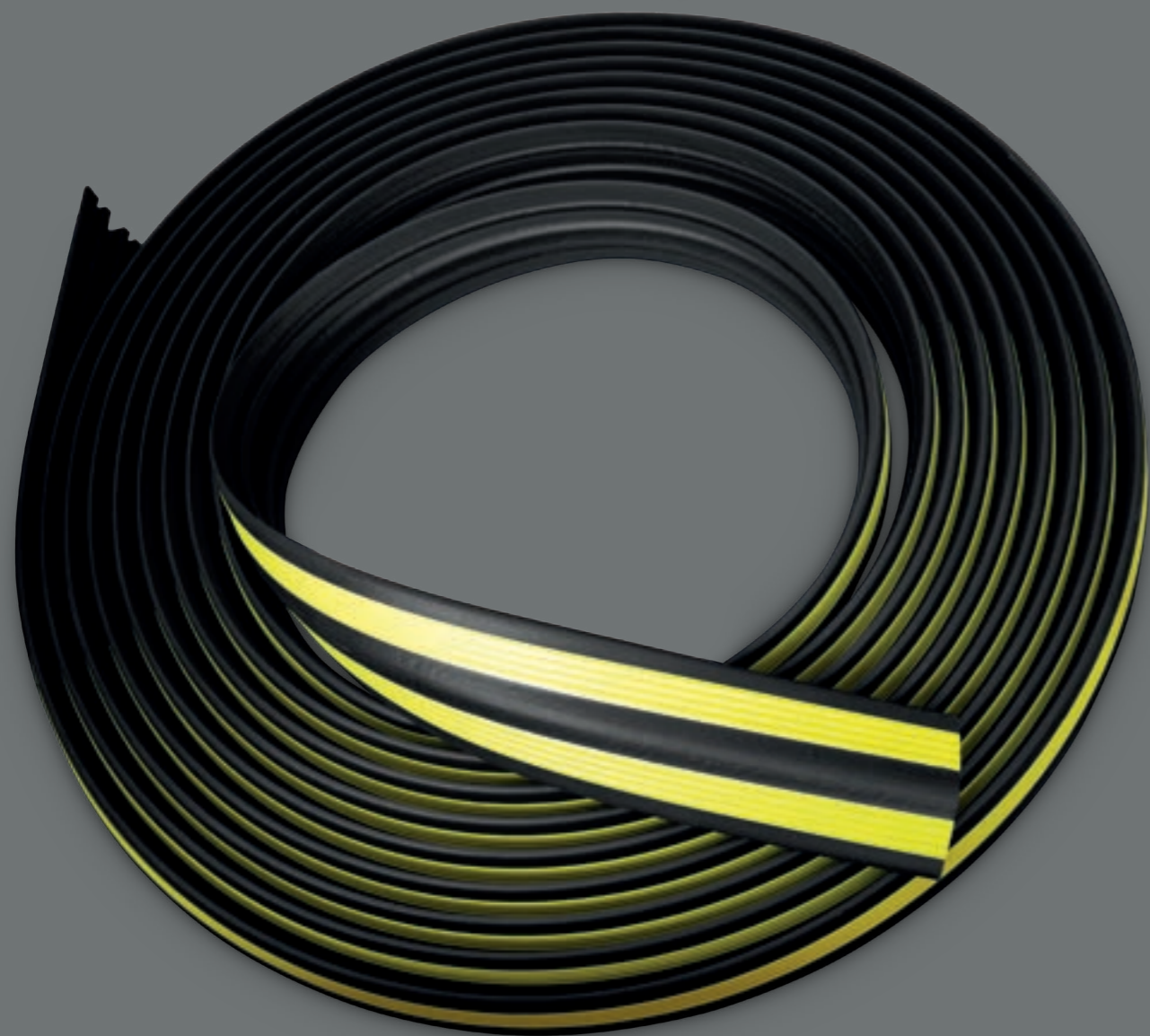

CABLE COVER

Kabelabdeckung

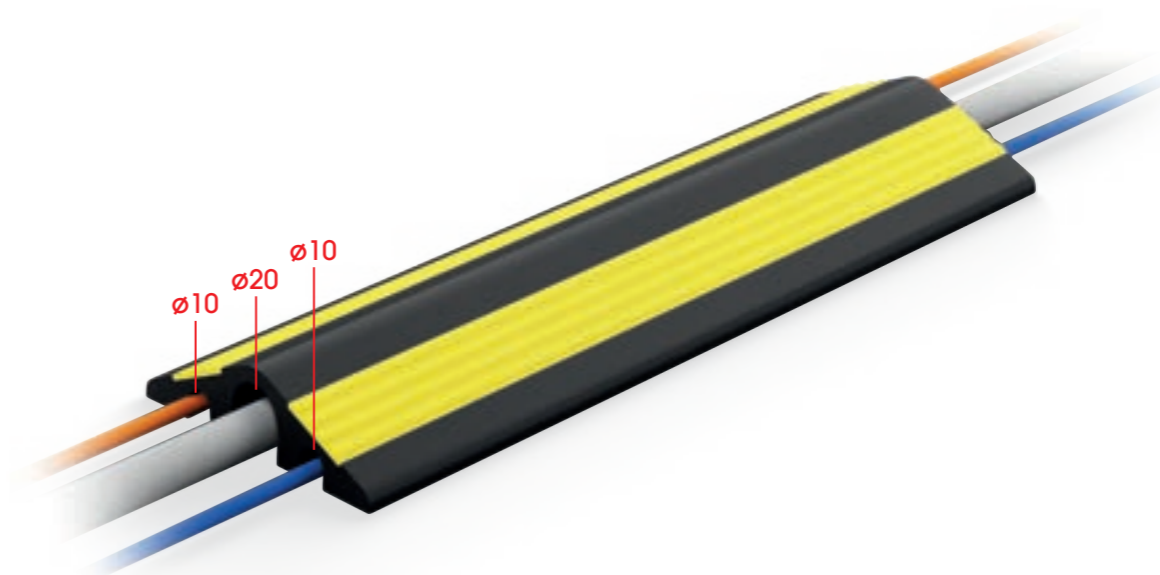

CAB CO 10 - 20 - 10

Recyclingmaterial

Länge 1.000 / 3.000 mm - 10.000 mm
VPE 8 St. / Karton - 1 St. / Karton

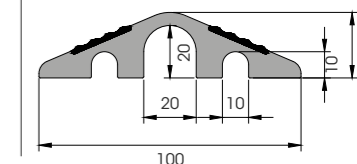

15

KANTENSCHUTZ

Zum Schutz gefährdeter Kanten von Säulen, Pfeilern und Wänden

Realizzato per proteggere pilastri e colonne o angoli esterni di muri e pannelli.

Etudié pour protéger les poteaux et les colonnes ou les angles extérieurs de murs et de panneaux.

Realizado para proteger pilares y columnas o esquinas exteriores de paredes y paneles.

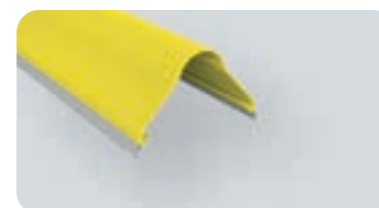

CP 100

Länge 4.000 mm
VPE 10 St. / Karton
Farbe **B** **M** **E** **F**

Länge 2.000 mm
VPE 10 pz / bag
Farbe **M**



CPF 100

Länge 4.000 mm
VPE 10 pz / bag

Länge 2.000 mm
VPE 10 pz / bag



CPT 100

VPE 40 St. / Karton
Farbe **B** **E** **F**

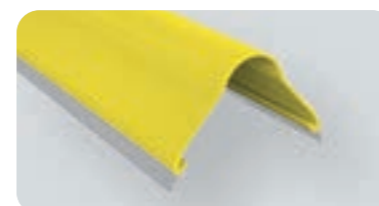

CP 200

Länge 4.000 mm
VPE 2 pz / bag
Farbe **B** **M** **E**

Länge 2.000 mm
VPE 2 pz / bag
Farbe **M**



CPF 200

Länge 2.000 / 4.000 mm
VPE 2 pz / bag



CPT 200

VPE 20 St. / Karton
Farbe **B** **E**

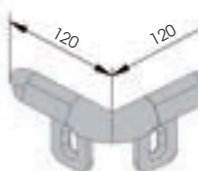

16

SOCKELLEISTEN

Ein breites Schutzsystem für Wände und Vertäfelungen. Durch intelligente Ecklösungen einfach zu Installieren und zu Reinigen.

Sistema di protezione di grandi dimensioni, ideale per muri e pannelli. Facile da installare e pulire. Completo di angolari e tappi.

Système de protection de grands dimensions, idéal pour les murs et les panneaux. Facile à installer et à nettoyer. Complété de bouchons d'angles et d'embouts.

Sistema de protección de grande dimensión, ideal para paredes y paneles. Fácil de instalar y limpiar. Completo de esquinas y tapas.

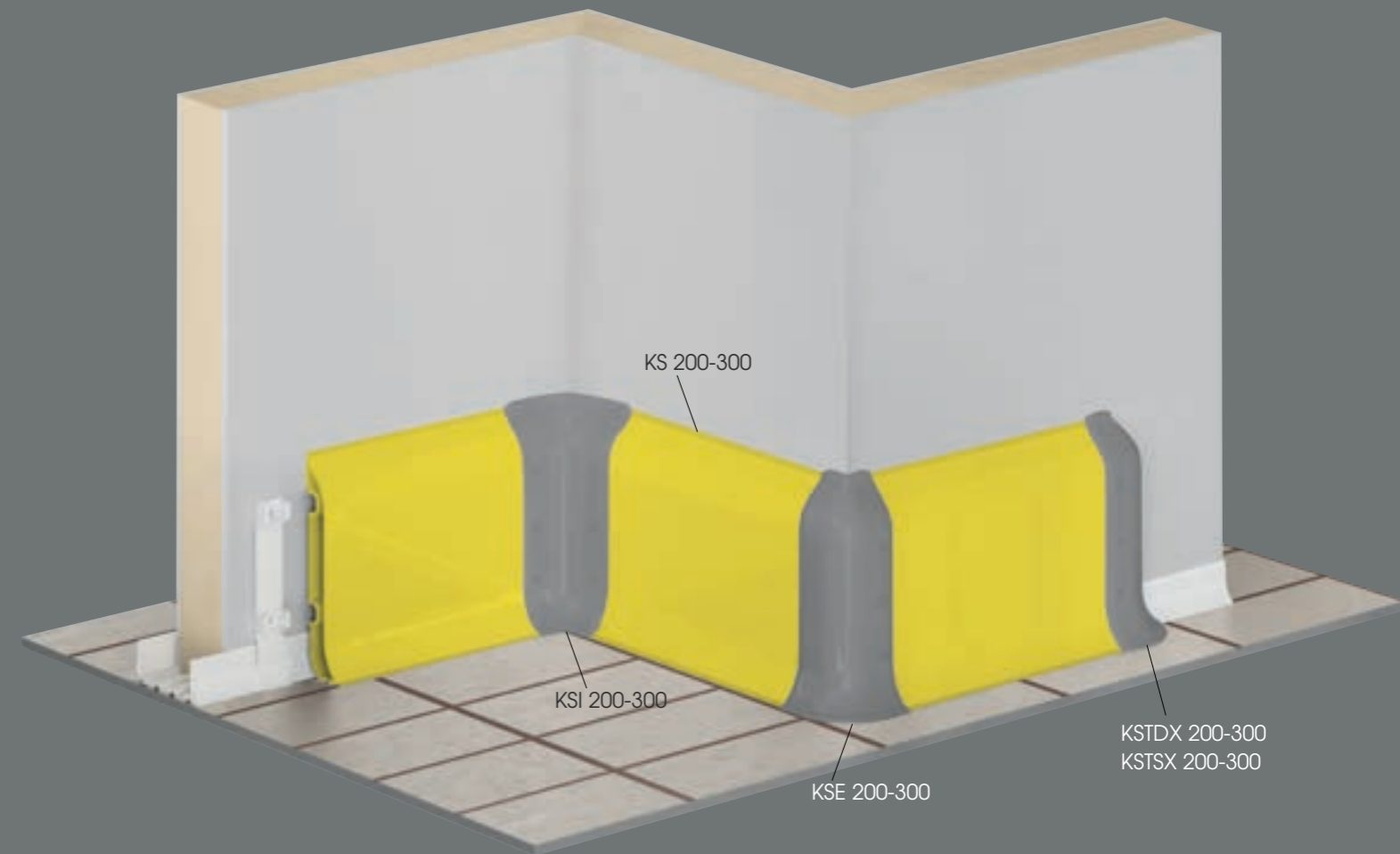



KS 200

Länge **4.000 mm**
VPE **3 St. / Karton**
Farbe **B M E**

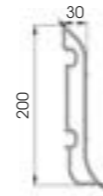

KEPF 200

Installieren mit TB14

VPE **50 St. / Karton**
Farbe **K**

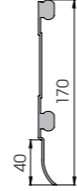

KSJ 200

Installieren mit TB14 / TF14

VPE **20 St. / Karton**
Farbe **B E**

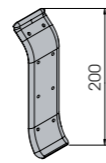

KSI 200

Installieren mit TB14 / TF14

VPE **20 St. / Karton**
Farbe **B E**

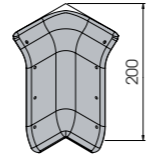

KSE 200

Installieren mit TB14 / TF14

VPE **20 St. / Karton**
Farbe **B E**

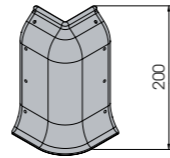

KSTD/SX 200

Installieren mit TB14 / TF14

VPE **20 St. / Karton**
Farbe **B E**

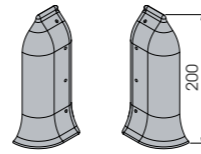

KSJ 200 LT



VPE **gewünschte Anzahl**
Farbe **K**

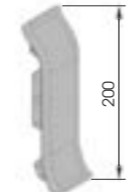

FLEXIBLES
VERBINDUNGSTÜCK



KS 300

Länge **4.000 mm**
VPE **1 St.**
Farbe **M E**

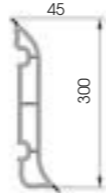

KEPF 300

Installieren mit TB20

VPE **40 St. / Karton**

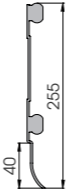

KSJ 300

Installieren mit TB20 / TF20

VPE **10 St. / Karton**
Farbe **B E**

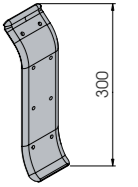

KSI 300

Installieren mit TB20 / TF20

VPE **10 St. / Karton**
Farbe **B E**

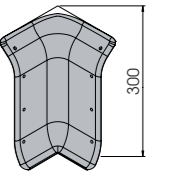

KSE 300

Installieren mit TB20 / TF20

VPE **10 St. / Karton**
Farbe **B E**

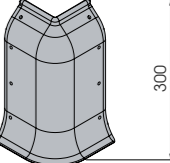

KSTD/SX 300

Installieren mit TB20 / TF20

VPE **10 St. / Karton**
Farbe **B E**

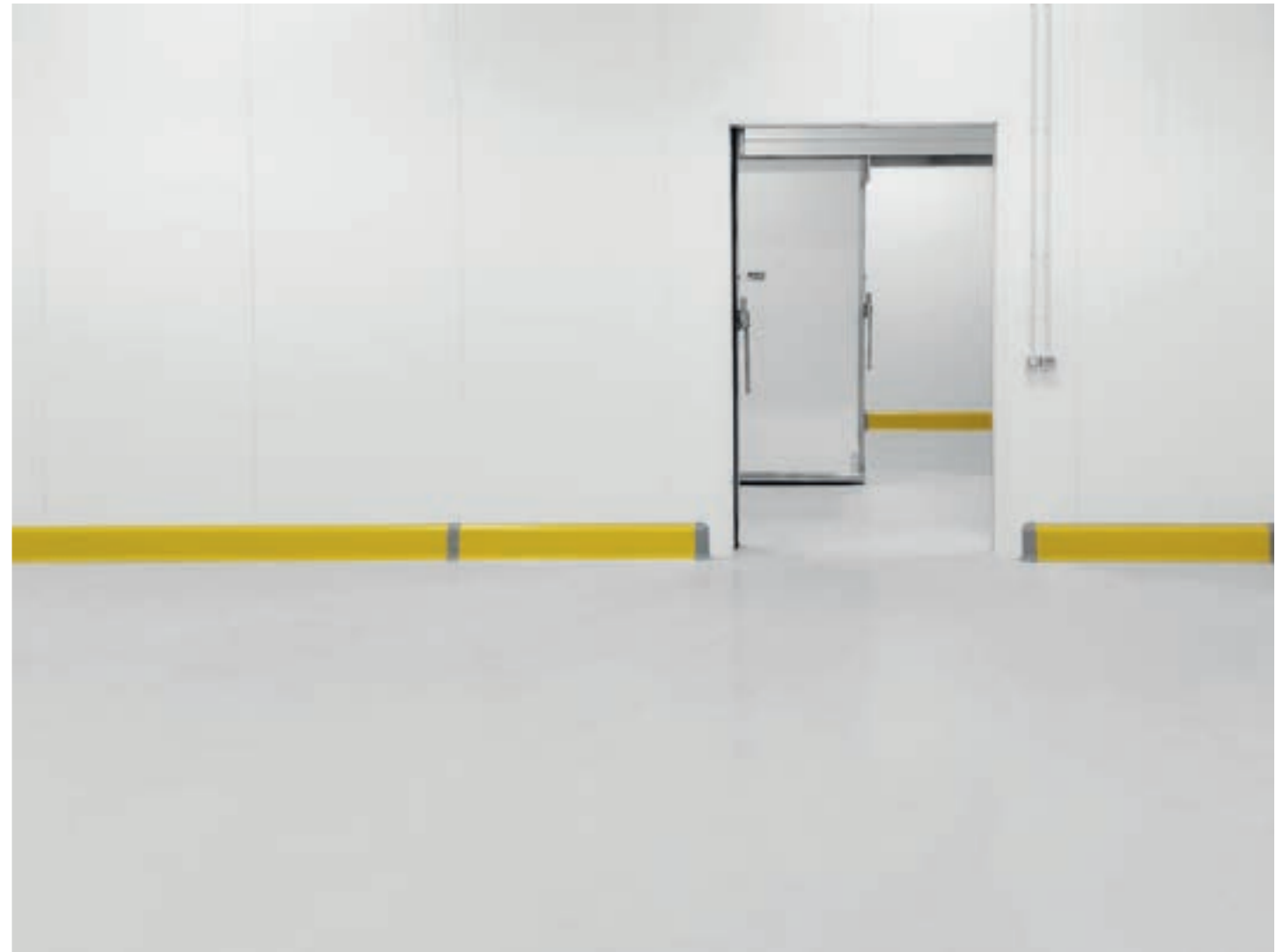
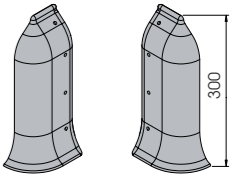

17

WANDSCHUTZ

Dank Größe und Widerstandsfähigkeit ideal geeignet zum Schutz von Wänden in Produktion und Logistik. Installation mit verdeckten Schrauben und speziellen Kappen.

Nuovo profilo antiurto senza guida. La sua ampiezza e resistenza lo rende ideale per la protezione di ambienti industriali. Terminali fissati con viti nascoste da appositi bottoni.

Nouveau profilé anti-choc sans besoin d'une base à fixer. Sa mesure large et sa résistance en font le profilé parfait pour la protection des espaces industriels. Embouts fixés avec des vis cachées grâce à des bouchons spécifiques.

Nuevo perfil antigolpe sin guía. Su amplitud y resistencia lo hacen ideal para la protección de entornos industriales. Terminales fijados con tornillos ocultos por botones especiales.



Wandschutz

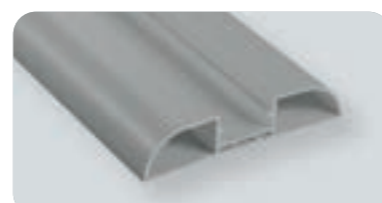

WP 100

Länge **4.000 mm**
VPE **8 St. / Karton**
Farbe **B E F**

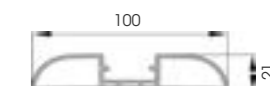

WP 150

Länge **4.000 mm**
VPE **4 St. / Karton**
Farbe **B M E**

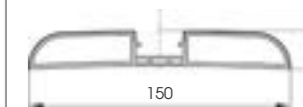

WPC

Installieren mit WP 100 / WP 150

Länge **4.000 mm**
VPE **16 St. / Karton**
Farbe **A B M D E F G H**

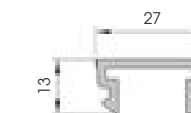

WPT 100

Installieren mit TM5

VPE **50 St. / Karton**
Farbe **B E F**



WPA 100

Installieren mit TS9

VPE **20 St. / Karton**
Farbe **B E**



WPT 150

Installieren mit TM5

VPE **50 St. / Karton**
Farbe **B E**

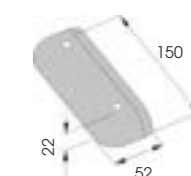

WPA 150

Installieren mit TS9

VPE **20 St. / Karton**
Farbe **B E**

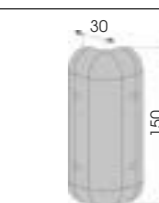

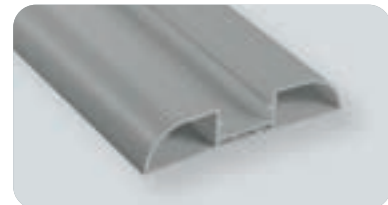
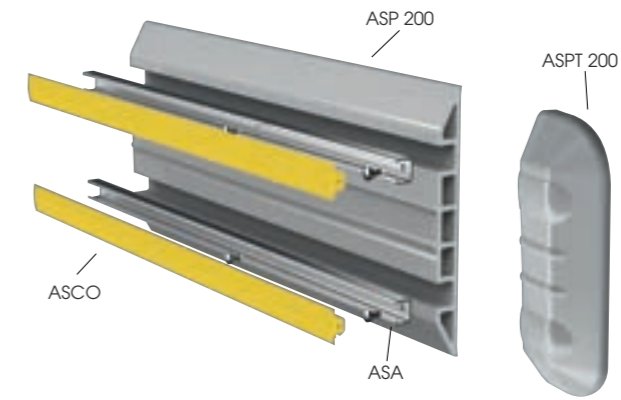
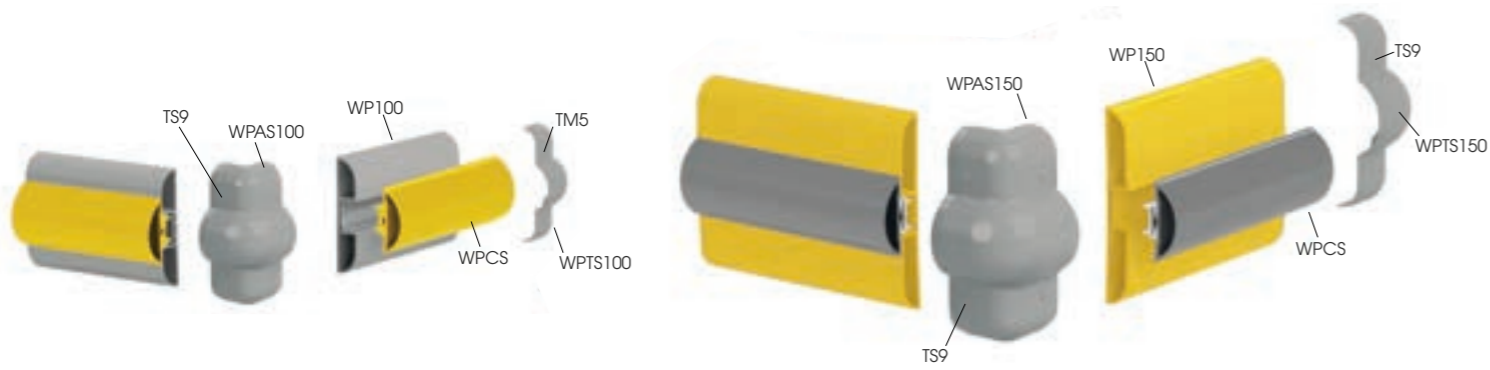

WP 100

Länge **4.000 mm**
VPE **8 St. / Karton**
Farbe **B E F**

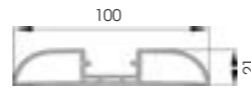

WP 150

Länge **4.000 mm**
VPE **4 St. / Karton**
Farbe **B M E**

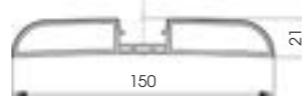

WPCS

Installieren mit WP 100 / WP 150



Länge **4.000 mm**
VPE **8 St. / Karton**
Farbe **A B M D E F G H I**

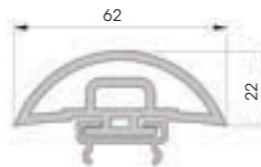

WPTS 100

Installieren mit TS9

VPE **20 St. / Karton**
Farbe **B E**

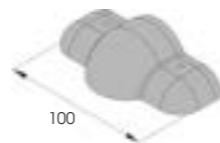

WPAS 100

Installieren mit TS9

VPE **20 St. / Karton**
Farbe **B E**

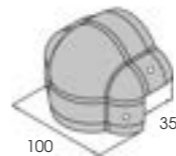

WPTS 150

Installieren mit TS9

VPE **20 St. / Karton**
Farbe **B E**

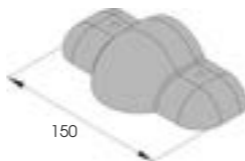

WPAS 150

Installieren mit TS9

VPE **20 St. / Karton**
Farbe **B E**

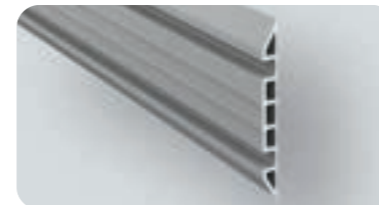
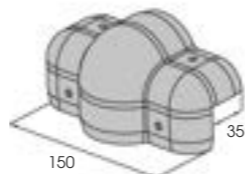

ASP 200



Länge **4.000 mm**
VPE **2 St. / Karton**
Farbe **B M**



ASPT 200



VPE **10 St. / Karton**
Farbe **B D**

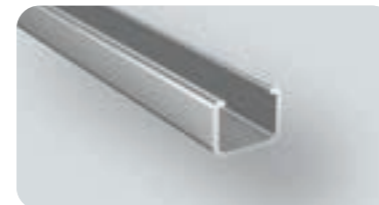
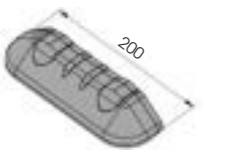

ASA

Material **aluminium**
Länge **4.000 mm**
VPE **8 pz / bundle**



ASCO



VPE **2 St. / Karton**
Länge **L = 32.000 mm**
Farbe **A B M D G**





WALL HUG 1000
2000
3000
4000

Länge 1000/2000/3000/4000
VPE unpacked
Farbe M

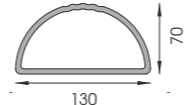

WALL BFLEX 1000
2000
3000
4000

Länge 1000/2000/3000/4000
VPE unpacked
Farbe M

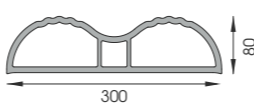

WALL BFLEX MODULAR

VPE unpacked
Farbe M

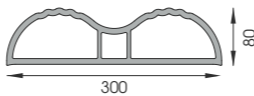

NEWS



LOFT BARRIER
DAS ERSTE SYSTEM FÜR ZWISCHENGESCHOSSE



PROTEX
SELBSTKLEBENDER KANTENSCHUTZ



RAMMSCHUTZBÜGEL LINK
STÄRKSTE KRAFTAUFNAHME
& INDIVIDUELLE HÖHE



INDIVIDUELLER
REGALSCHUTZ
FÜR JEDEN
REGALTYP!

INDIVIDUELLER RP **SUPER**

Befestigungsmaterial



M12 - M16

HILTI

Bohrung erforderlich Ø 12-16
Verzinkter Stahl.



S12 - S12X150 - S16

HILTI

Bohrung erforderlich Ø 10-10-14
Verzinkter Stahl.



B12 - B16 - B20

HILTI

Bohrung erforderlich Ø 22-28-32
Verzinkter Stahl.



S8FH - S12FH

HILTI

Bohrung erforderlich Ø 6-10
Verzinkter Stahl.
Versenkt.



SF12 - SF16 - SF20 INOX

Bohrung erforderlich Ø 14-18-24
Edelstahl Stahl.



M12 - M16 INOX

Bohrung erforderlich Ø 12-16
Edelstahl Stahl.



KIT ROD 70-120

HILTI

Bohrung erforderlich Ø 38-56
Verzinkter Stahl.



KIT ROD 70-120 INOX

HILTI

Bohrung erforderlich Ø 38-56
Verzinkter Stahl.



AA12 - AA16

Bohrung erforderlich Ø 22-22
Verzinkter Stahl.
für Asphalt.



ASPHALT CHEMICAL

CHEMISCHE ANKER
385 ML



WIT NORDIC

CHEMISCHE ANKER
420 ML
(für Kühlräume mit negativen
Temperaturen)



FR

HILTI CHEMISCHE ANKER
300 ML

in Zusammenarbeit mit



MPM behält sich jederzeit notwendige Veränderungen und Verbesserungen an den Produkten vor.
Mögliche minimale Abweichungen bei Material und Produkten sind produktionsbedingt.
Die vollständige oder teilweise Reproduktion dieser Broschüre ist untersagt.

Befestigungsmaterial



TM5

Bohrung erforderlich Ø 8.5
Neutral polyethylene. 100/500 Pcs. / bag.



TS9

Bohrung erforderlich Ø 5
Nylon weiß oder grau. 1000 Pcs. / bag.



TB14 - TB20

Bohrung erforderlich Ø 4-5
Stahl / Aluminium (white for Ø 4)
500 Pcs. / box.



TF14 - TF20

Bohrung erforderlich Ø 5-6.5
Aluminium. 500 Pcs. / box.



FIX P90

Galvanisierter & lackierter Stahl.



COVER 90 RE

Galvanisierter & lackierter Stahl.



FIX P90 INOX

Edelstahl Stahl.



FIX P150

Galvanisierter & lackierter Stahl.



COVER 150 RE

Galvanisierter & lackierter Stahl



FIX P150 INOX

Edelstahl Stahl.



FIX P150 FH

Galvanisierter & lackierter Stahl.
Versenkt.

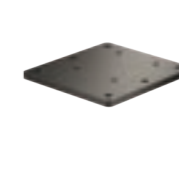

FULL FRAME BASE

Galvanisierter & lackierter Stahl.



SHOCK ABSORBER PAD

Elastisches material, optional für fixp150
(Installieren mit s12x150)

Farben

A	B	D	E	F	G	H	I	K	L	M	P
ROT RAL 3002	GRAU RAL 7040	SCHWARZ RAL 9005	WEISS RAL 9010	WEISS RAL 9002	BLAU RAL 5005	GRÜN RAL 6029	SILBER RAL 9006	HELLGRAU RAL 7035	DUNKELGRAU RAL 7024	HELLGELB RAL 1018	ORANGE

MPM behält sich jederzeit notwendige Veränderungen und Verbesserungen an den Produkten vor.
Mögliche minimale Abweichungen bei Material und Produkten sind produktionsbedingt.
Die vollständige oder teilweise Reproduktion dieser Broschüre ist untersagt.



EINIGE ANWENDUNGSBEISPIELE



DIE FÜHRENDEN **LOGISTIK**-UND
 PRODUKTIONSBETRIEBE VERTRAUEN
 UNSERER **QUALITÄT MADE IN ITALY**



ANWENDUNGSBEISPIELE

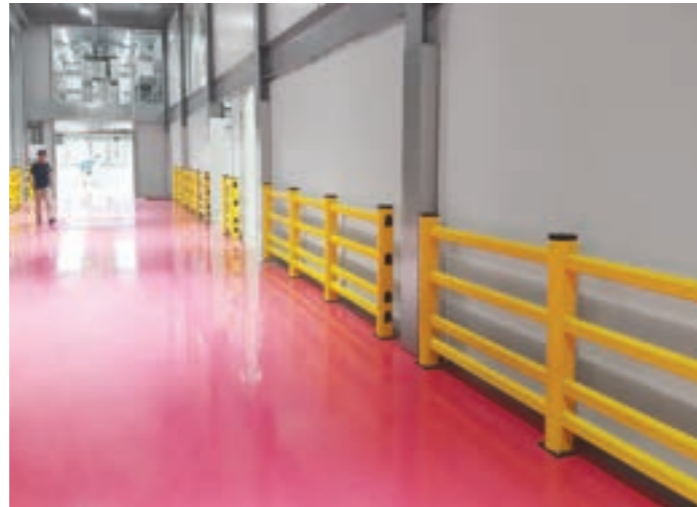

ANWENDUNGSBEISPIELE



ANWENDUNGSBEISPIELE

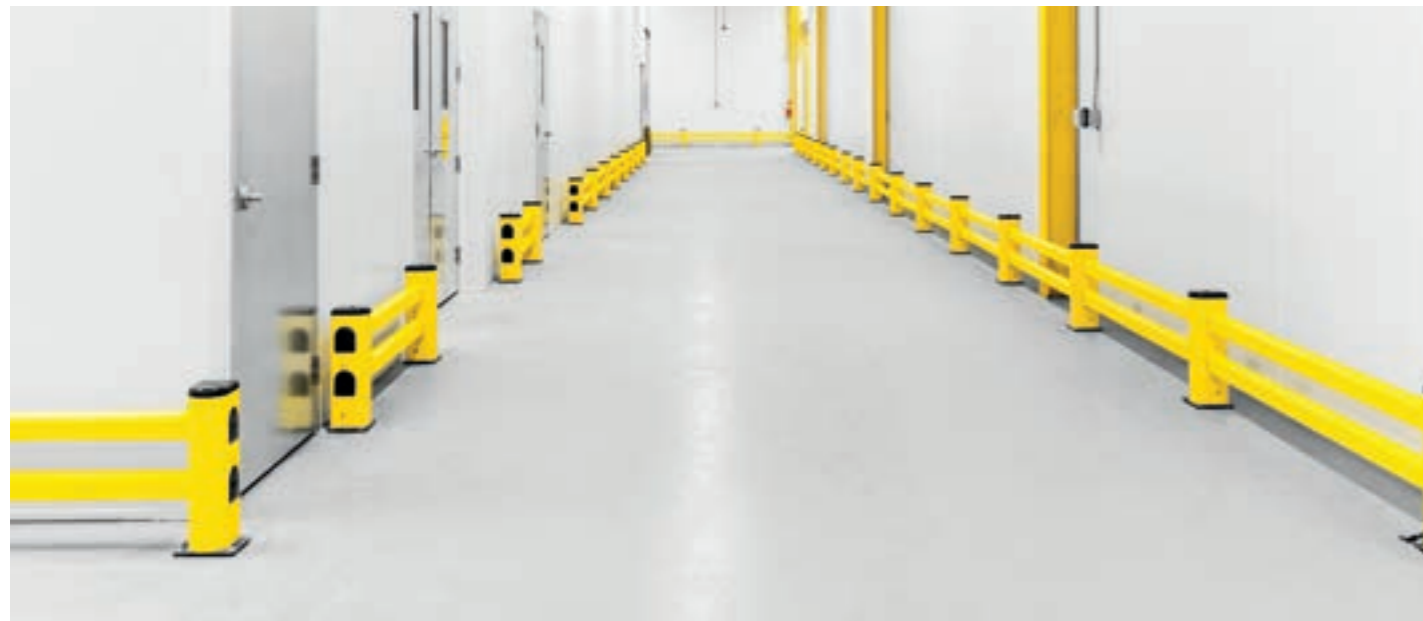

MPM states that:

The safety coefficient and consequent use of the products requires the compliance with the appropriate assembling and installation instructions as defined in the technical catalogue on the corporate website www.mpmprotections.com. Therefore, before buying and installing MPM solutions please consult the technical data sheet of each product in the technical catalogue available on www.mpmprotections.com

Impact resistances indicated in the brochure, or in other documents, refer to laboratory tests and cannot take into account consequences determined by installation methods or peculiarities of the place where the products are installed (in an operational environment vehicle type, speed and mass, routes, angles of impact, ground and anchorage are variable and uncontrolled conditions that no test can replicate); the data refers to an intact product which length is indicated on the test report and it can be affected by alterations from incorrect maintenance, wear and tear, as well as the methods and characteristics of installation (with specific reference to floor-mounted products); the weight, dimensions, colours and characteristics of the material refer to the sample and the conformity with the latter of the product supplied will be subject to normal production tolerance. The product may be affected by environmental installation conditions.

The standard operating temperature of MPM flexible protections is generally from +5 °C to +60 °C. For installations in low temperature environments up to -30 °C an alternative material should be required. The fastness of the colour and its brightness depend on wear and tear and weather conditions that can affect its intensity over time. For outdoor applications exposed to direct sunlight it is possible to choose the grey colour.

Images in the brochure are for advertising purposes only and do not in any way represent how the products should be used.

Full version of MPM products warranty available on corporate website www.mpmprotections.com





*ALWAYS
DYNAMIC*



M.P.M. s.r.l.
Via Europa 2
35010 Fratte
di S. Giustina in Colle
Padova · Italy

T +39 049 9301773
F +39 049 9300427
info@mpmpvc.com
mpmprotections.com

SOMMER 2022